

## Optical Fiber Arc Fusion Splicer

Read this user manual carefully before running K11.

# SWIFT K11

USER MANUAL

This device complies with Part 15 of the FCC Rules. Operation is subject to the following two conditions: (1) This device may not cause harmful interference, and (2) this device must accept any interference received, including interference that may cause undesired operation.

Device Type	Notification
A Class Device (Broadcasting and communication device, commercial use)	Users need to understand that this device(A Class) has obtained EMI(Electromagnetic compatibility) and been designed to be used in places other than home.

Telephone 042 671 5607~8

Homepage [www.ilsintech.com](http://www.ilsintech.com)

E-mail [saleskorea@ilsintech.com](mailto:saleskorea@ilsintech.com)

# TABLE OF CONTENTS

---

<b>I. NOTES FOR USERS</b>	<b>3</b>
<b>II. PRODUCT SPECIFICATIONS AND COMPOSITION</b>	<b>7</b>
2.1 Product specifications	7
<b>III. PRODUCT OUTLINE</b>	<b>10</b>
3.1 Function buttons	10
3.2 Component's name	11
<b>IV. INSTRUCTIONS FOR USE</b>	<b>13</b>
4.1 Power supply	13
4.2 How to turn the power ON/OFF	17
4.3 Sleeve loader assembly	17
4.4 Inserting optical fiber to protecting sleeve	18
4.5 Optical fiber cleaning and stripping	19
4.6 Optical fiber cutting	19
4.7 Installing optical fiber to sealer	21
4.8 Optical fiber connecting procedure	22
4.9 K11 Sleeve-Heater part	23
4.10 Separation of connected optical fiber	25
4.11 Heating for protecting sleeve	25
<b>V. MAINTENANCE OF SPLICE QUALITY</b>	<b>26</b>
5.1 Cleaning and Inspection before splice	26
5.2 Regular cleaning and inspection	28
<b>VI. MENU</b>	<b>32</b>
6.1 Splice	39
6.2 Heater	48
6.3 Splice result	52
6.4 Option	53



6.5	Calibration	58
6.6	Electrode	63
6.7	Setting	67
6.8	Information	71
<b>VII.</b>	<b>ERROR MESSAGE</b>	<b>74</b>
7.1	Optical fiber is too dirty.	74
7.2	Replace the optical fiber.	74
7.3	Optical fiber is too long.	75
7.4	Error on angle of optical fiber	75
7.5	Loss is big.	76
7.6	Optical fiber is thin.	76
7.7	Optical fiber is thick.	76
7.8	Bubble being generated	77
7.9	Error on cut surface on left, right or both	77
<b>VIII.</b>	<b>SEALING PROBLEM SOLVING</b>	<b>78</b>
8.1	When loss is big	78
8.2	Abnormal sealing operation	79
<b>IX.</b>	<b>PROBLEM OCCURRENCE AND QUESTION</b>	<b>80</b>
9.1	Power	80
9.2	Splice	81
9.3	Sleeve heater	82
9.4	Others	83
<b>X.</b>	<b>WARRANTY AND REPAIR</b>	<b>84</b>
10.1	Information necessary for repair	84
10.2	Transportation	85
10.3	Repair	85



# I. NOTES FOR USERS

---

Swift K11 is designed to be conveniently used both indoor and outdoor work sites so its use is easy and simple but make sure to read this instructions for use to prevent safety accident and breakdown before using Swift K K11. The instructions for use provide information necessary for safe splice.

**Carry the instructions for use with the product at all times.**

Ilsintech does not take any responsibility for the equipment's damage and personal or physical loss incurred due to improper use or alteration.

## Warnings

When any of the following occurs during use, turn off the power immediately and contact to Ilsintech.

Smoke, disgusting smell, noise or abnormal overheating.

When a foreign substance or liquid falls into the equipment

When the sealer falls down or it is damaged

Do not touch the electrode when power of Swift K11 is on. High voltage and high temperature generated from electrode may incur serious chock or burn.

Connect the provided AC power cord to battery. Check whether there is any foreign substance on the terminal before connecting to AC power socket.

Incomplete splice may incur smoke, electric shock, fire, damage of equipment, serious injury and even death.

## Warnings

Use proper power.

AC power for the adapter is AC100-240V, 50~60Hz.

Test the AC power before use. When output voltage of AC power is high or abnormal frequency is generated, the product is damaged and serious injury or even death may be incurred to the user.

AC output voltage should be measured using circuit tester before connecting AC power cable and regular inspection should also be conducted.

Do not pull the provided AC power cord by force or heat or transform it.

When a damaged power cord is used, it may incur fire or injury.

Use 3-core AC power cord and do not ever use 2-core power cord, cable or plug.

Do not touch AC plug, AC power cord or sealer with wet hands. It may incur electric shock.

Do not disassemble AC adapter, battery or Swift K11. Deformation may incur fire, electrical shock or injury.

Refer to the following when using the battery.

- When an improper battery which is not provided by Ilsintech is used, it may incur smoke, damage of equipment, burn, injury or even death.
- Do not dispose the battery into fire or incineration plant.
- Do not charge the battery next to flame.
- Do not give an excessive shock to the battery.
- When the battery is not completely charged in 2 hours or green LED is not turned on, stop charging immediately and contact to Ilsintech.

Do not put anything on AC adapter during charging.

Use the exclusive AC adapter (F1-1). Do not use another AC power cord or battery. Excessive current may incur equipment damage or injury.

Do not use Swift K11 where there is harmful gas or flammable liquid. Explosion or fire may be incurred due to electrical discharge.

## Warnings

Do not use compressed air or compressed gas when cleaning Swift K11.

Inspect the case belt before transportation. When transporting case is dropped due to damage on belt, it may incur equipment damage or injury.

Wear safety goggles when working on making splice. It is very dangerous if a piece of optical fiber gets in skin or eye.

Do not use Swift K11 around high temperature or flame. It may incur injury or equipment damage.



: Caution for high temperature

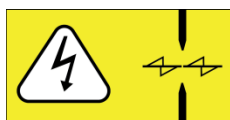

: Caution for high voltage

## Cautions

Do not touch sleeve heater or protec sleeve while sleeve heater is operating or right after heating is completed. It may incur injury due to high temperature.

Do not put Swift K11 at an unstable place. When the equipment is dropped, it incurs injury or equipment damage.

Swift K11 should be accurately adjusted and treated in arrayal. Do not give it a strong shock, either.

Use transporting case to carry or to keep Swift K11. The transporting case keeps the equipment from humidity, vibration and shock during storage and transportation and prevents its damage.

Replace the electrode at the right time by referring to the following.

- Designated electrode should only be used.
- Place a new electrode at a right position.
- Replace the electrode in pairs.

Abnormal discharge is incurred when not following the aforementioned caution.

It may incur equipment damage or deteriorated splice.

Do not use any chemical other than ethyl alcohol (96% or higher) to clean object lens, V-Groove, LCD monitor and main body.

Using other chemicals may incur deformation, discoloration or deteriorated performance.

Do not keep the equipment in environment with high temperature or high humidity. It may incur equipment damage.

Technical aspects of Swift K11 should be inspected by a qualified expert.

When ignoring this, it may incur fire or electric shock.

Discuss with Ilsintech to use the service.



## II. Product specifications and composition

---

### 2.1 Product specifications

Item	Description
Optical fiber arrayal	IPAAS core arrayal method
Optical fiber type	0.25mm, 0.9mm, 2.0mm, 3.0mm, 4.0, Indoor cable
Number of optical fiber core wires	Single
Optical fiber diameter	Clad diameter: 80~150 $\mu\text{m}$ , Coating diameter: 100 $\mu\text{m}$ ~4mm
Optical fiber cutting length	7.0mm ~ 16mm
Splice mode	Splice mode: 300, Heater mode: 100
Splice loss	SM: 0.02dB, MM: 0.01dB, DS: 0.04dB, NZDS: 0.04dB
Reflection loss	> 60Db
Sealing time period	About 6 seconds (Quick mode)
Sleeve heating time	9 seconds (IS-45 sleeve, IS-45 mode), 13 seconds (IS-60 sleeve, IS-60 mode)
Protecting sleeve	40mm, 60mm, 32mm or 28mm (For SOC)
Data storage	Internal memory capable of saving 10,000 times (Saving 10,000 images)
Tensile strength	1.96N ~ 2.25N
Size	143(W) x 163(L) x 140(H)mm
Weight	2.25kg



Optical fiber magnification	X/Y : 220X, Max 440X
Power	DC lithium polymer battery (DC 14.8V, 4700mAh), 100~240V AC adapter
Battery capacity	Usable about 250 times
Electrode life	Capable of sealing about 3,500 times without replacement
Splice terminal	USB, RCA, external power(DC 12V vehicle cigar jack splice)

## 2.2.1 Basic components

Item	Model name	Quantity
Optical fiber sealer	Swift K11	1
AC adapter	F1-1	1
Spare electrode	EI-23	1 set
Battery	K11-4700	1
Instructions for use	-	1
Transporting case	Hard Case	1
Alcohol dispenser	PP	1
Manual stripper	CF-02	1
Cooling Tray	CT-01	1
Sleeve Loader	S312	2
DC Output Cable	-	1
Tool Box	-	1
Screw Driver	LD-3300	1
USB Cable	-	1







## 2.2.2 Accessories

Item	Model name
Battery	K11-4700
Cutter blade	BI-05
Electrode	EI-23
Optical fiber holder	HS-250, HS-900, HS-2.5, HS-IN,HS-SC/FC, HS-LC, HS-ST,LS-900
Sleeve	S-160(60mm), S-140(40mm)
Sleeve clamp	SC-01
Work belt	WB-01
SOC connector	SC, LC, FC, ST [See Ilsintech website.]
Cutter	CS-03A
External power	DC 12V vehicle cigar jack

## III. Product outline

### 3.1 Function buttons

Button	Description
	<p>Press about for 1 second to turn the power ON/OFF. Press about for 1 second when power is on and the LCD monitor is turned off and so is power after 2~3 seconds.</p>
	<p>Key to load menu screen It switches to splice screen. Every time it is pressed, it switches to X screen, Y screen and X, Y sync screen.</p>
	<p>It operates sleeve heater. When it is ON, the lamp on the left is turned on red. Press once more when it is ON and the heater is turned off.</p>
	<p>It goes back go initial screen. It initializes splice function.</p>
	<p>Key for splice executive command</p>

### 3.2 Component's name





Button to show remaining battery

Remaining battery indicator

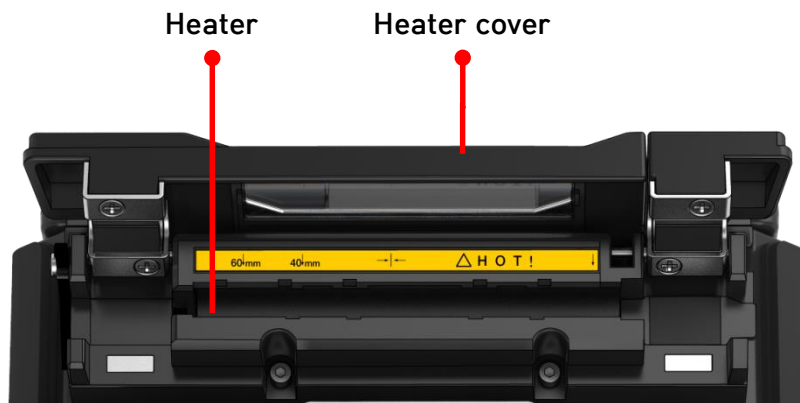

Heater

Heater cover

## IV. Instructions for use

The following is the initial screen of Swift K11. For accurate splice result, splice mode and heater mode should be properly selected. Basic information on Swift K11 is displayed on the initial screen. Check whether a proper mode is selected before splice.

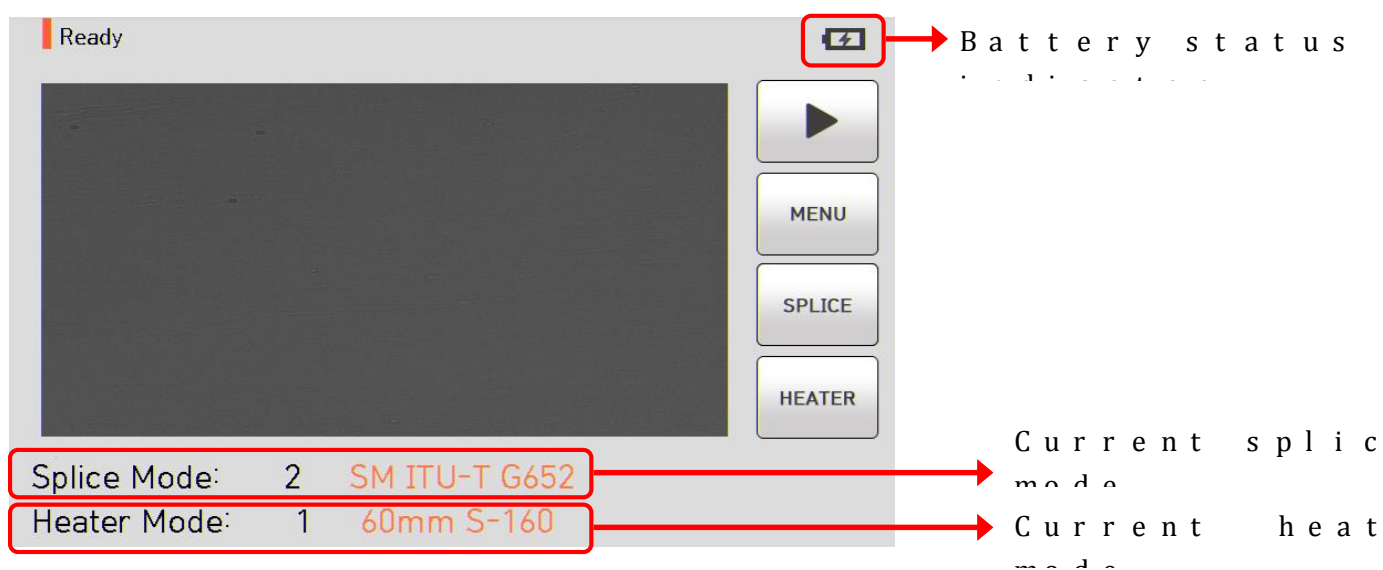

### 4.1 Power supply

Use the AC adapter (F1-1) and battery provided with the product. Using other products may incur fire, equipment damage or accident.

## 4.1.1 Battery installation

Push the battery in until it is completely installed.



Check whether the power is off before removing the battery and press the locking lever to remove the battery.



















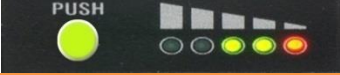

#### 4.1.2 Battery charging

Check the voltage and frequency and connect DC jack of battery and DC cable of AC/DC adapter. When battery is fully charged, its LED turned green and power is disconnected upon protective action with built-in overdischarge, overcharge and overload protection circuit. In this case, the power is turned back on and charging resumes when DC cable of adapter is connected to DC jack of the battery again. With the floating charge method, Swift K11 can be charged during use and with 12V cigar jack as well.

### 4.1.3 Battery capacity check

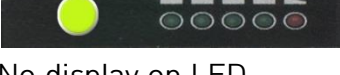
Press  and the current remaining amount is displayed.

Remaining battery display (Monitor)	Remaining battery indicator (Battery LED)	Remaining battery
 (5 bars)	 5 LED	80 ~ 100%
 (4 bars)	 4 LED	60 ~ 80%
 (3 bars)	 3 LED	40 ~ 60%
 (2 bars)	 2 LED	20 ~ 40%
 (1 bar)	 1 LED	10%
 (No bar)	 0LED No display on LED	5% or none

 When the remaining battery is indicated 10% or below, charge the product for use. It may affect splice quality.

## 4.2 How to turn the power ON/OFF

To turn on the power of Swift K11, press  for about 1 second with the windbreak cover being closed. After the entire functions including motor are initialized, the initial screen is subsequently displayed as follows. For accurate splice, splice mode and heater mode should be properly selected. Current splice mode, stripping mode and heater mode are displayed at the bottom of the screen.

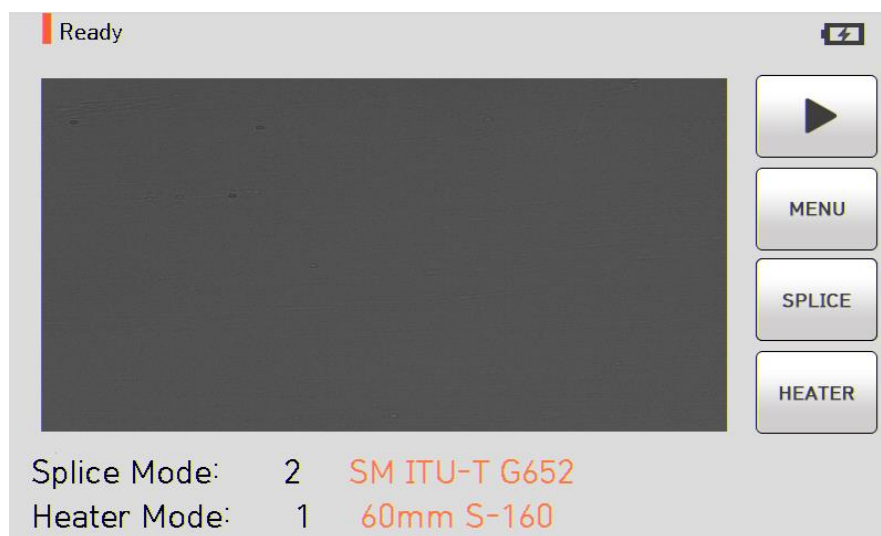

## 4.3 Sleeve loader assembly

Insert the sleeve loader at the left/right grooves as shown in the figure below.

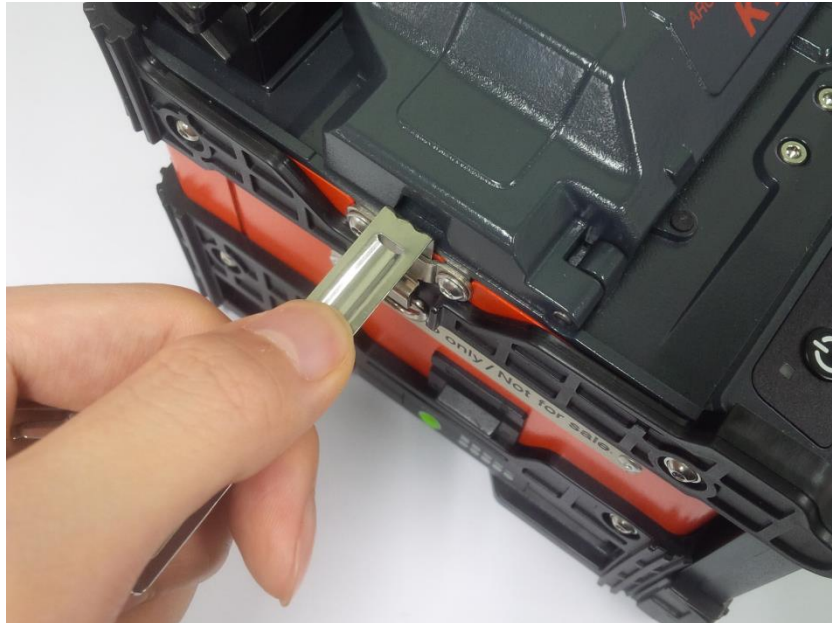

#### 4.4 Inserting optical fiber to protecting sleeve

Put optical fiber in protecting sleeve.



## 4.5 Optical fiber cleaning and stripping

Do stripping procedure on about 4cm from the end of optical fiber by using sheath stripper.

And wipe the optical fiber clean with soft cloth or cotton moistened with alcohol.

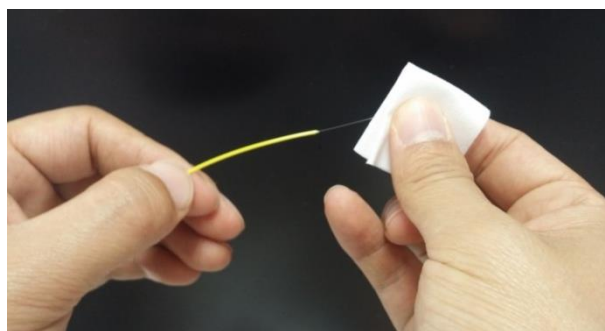
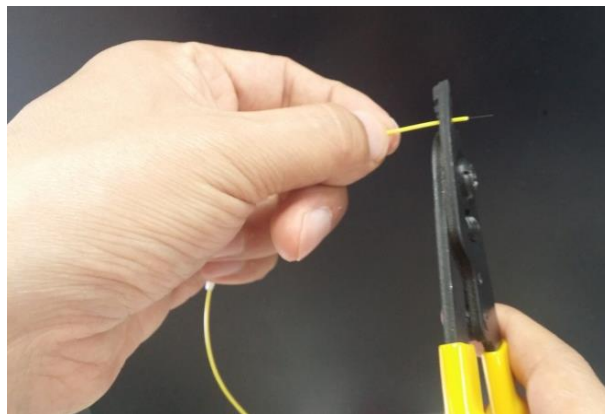

⚠ Use ethyl alcohol with purity of 96% or higher.

## 4.6 Optical fiber cutting

- i. Install the optical fiber on cutter as shown in the figure below and check optical fiber's state and cutting length. When optical fiber is not properly installed, problems may be incurred on cutting procedure.

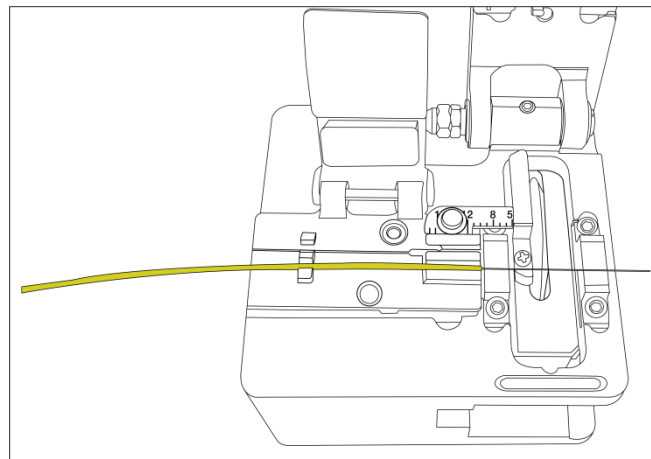

- ii. Push the cutting lever down and the optical fiber is being cut.
- iii. Lift the cutting lever and take the optical fiber out.
- iv. Remove the cut pieces of optical fiber and dispose in a proper container.

 For the detailed use of cutter, refer to the instructions for cutter use.

## 4.7 Installing optical fiber to sealer

- i. Open the windbreak cover and optical fiber clamp.

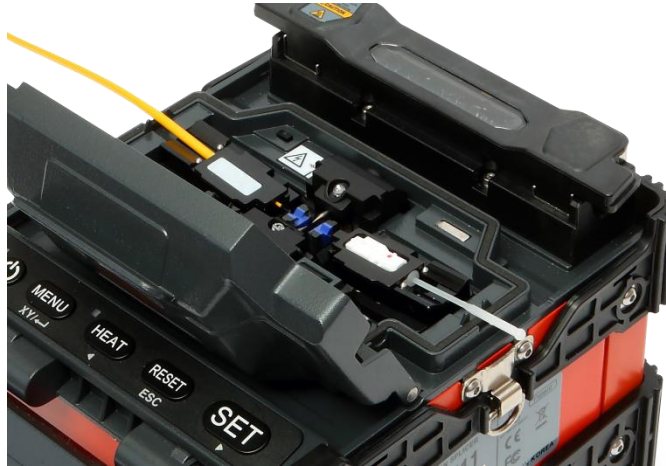

- ii. Put optical fiber between V-Groove and electrode. Be careful not to make the tip of prepared optical fiber bump against other objects.
- iii. Fix the optical fiber with hands to prevent its move and close the clamp with care.
- iv. Install the optical fiber on the opposite side in the same way.
- v. Close the windbreak cover with care.

 The better the optical fiber is installed at a proper location, the shorter it takes for arrayal.



## 4.8 Optical fiber connecting procedure

State of optical fiber can be observed by using image processing system installed on Swift K11. For better splice result, however, visual inspection is additionally required. Upon auto mode, splice procedure automatically starts when windbreak cover is closed.

- i. Optical fibers installed on sealer advance toward each other. Advancing optical fibers move to a location where splice can be done after cleaning discharge. After that, the sealer checks cutting angle of optical fiber, the state of tip's cross section, dust, etc. When the measured cutting angle is bigger than the preset limitation or when damage is detected on optical fiber, error message is displayed on the screen. And splice procedure stops as well. Even when there is no error message displayed, however, visual inspection on the monitor screen is always recommended.
- ii. Optical fibers are arrayed core vs core after inspection. Deviation on clad axis and deviation measured on core axis can be displayed on screen.
- iii. After alignment completes, arcing is conducted to splice fibers.
- iv. After splice completes, estimated loss value is displayed on screen. Estimated value of splice loss is subject to various factors related to error. These factors related to error affect estimation and calculation of estimated loss value as well. Calculation of estimated loss is based on factors such as MFD. When estimated loss value exceeds the preset limitation, error message is displayed on the screen. The error message is also displayed when the spliced optical fiber is too thick or thin or when bubbles are generated on the joint. Even when there is no error message displayed, however, it is recommended to conduct sealing yet again when the splice result on screen is considered not good enough.
- v. Splice result is saved as follows.

When splice completes, splice result is automatically saved.

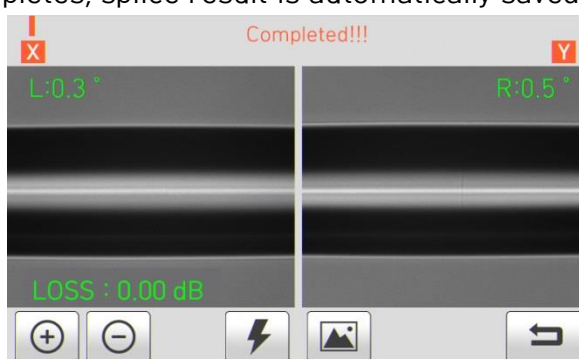



## 4.9 K11 Sleeve-Heater part

Sleeve heating part of K11 realizes reinforcement of single optical fiber subject to sealing splice.

State of sealing splice on optical fiber should be appropriate.

Optical fiber that sleeve tube is inserted to heater should be appropriately arrayed and installed.

Heater cover should be closed upon sealing.

Cable diameter	$\Phi 250\mu\text{m}$ , $\Phi 900\mu\text{m}$ , $\Phi 2.0\text{mm} \sim \Phi 3.0\text{mm}$
Sleeve length	20mm~60mm
Sleeving time	10~150 sec
Temperature range	130°C ~ 200 °C

- i. Make preparations by opening the heater cover.
- ii. Fit the sleeve tube into a part to be reinforced of sealed optical fiber and press the optical fiber inside the heater to settle it down.

In case of Connector type, fit into the right end of heater to press the sleeve into the heater as tight as possible.



- iii. After settling the optical fiber, operate the heater by pressing



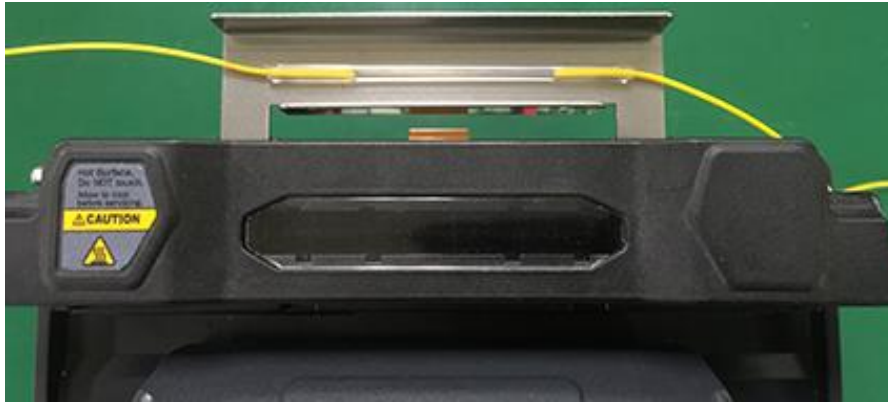

- iv. 히터가 완료되면 커버를 열어 보강된 광섬유를 꺼내 cooling Tray로 이동하여 sleeve를 냉각합니다.

## 4.10 Separation of connected optical fiber

- i. Open the cover of sleeve heater.
- ii. Open the windbreak cover.
- iii. Hold the optical fiber on the left and open the clamp on the left.
- iv. Open the optical fiber clamp on the right.
- v. Hold the both sides of spliced optical fiber and separate optical fiber from Swift K11 with care.

## 4.11 Heating for protecting sleeve

- i. Move a splicing point to the center of protecting sleeve. Make the protecting support of sleeve face the bottom.
- ii. Place the protecting sleeve at the center of sleeve heater.
- iii. Hold the both sides of optical fiber and pull downwards as shown in the figure and the heater cover is automatically closed.
- iv. Heating starts by pressing  .
- v. LED is turned off when heating completes.
- vi. Open the heater cover and separate optical fiber. Do not touch protecting sleeve or heater right after the heating.
- vii. Conduct final inspection on whether there are bubbles, fragments or dusts on sleeve.

## V. Maintenance of splice quality

---

### 5.1 Cleaning and Inspection before splice

#### 5.1.1 V-Groove cleaning

When the inside of V-Groove is contaminated, splice quality may deteriorate. Thus, it is important to regularly inspect and frequently clean the V-Groove as follows.

- i. Open the windbreak cover.
- ii. Clean the V-Groove using cotton swab moistened with alcohol. Remove the alcohol remaining on V-Groove using a clean and dry cotton swab.
- iii. When a foreign substance is not removed with cotton swab, clean it with the tip of cut optical fiber and then repeat the step above.

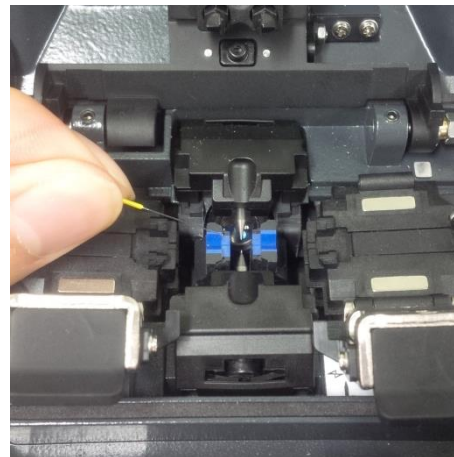
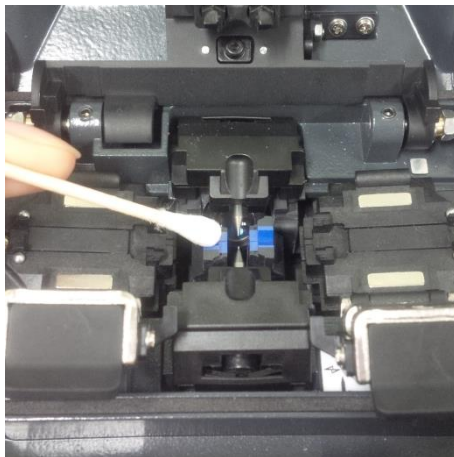

### 5.1.2 Pusher Block cleaning

Contaminations remaining on Pusher Block incur poor splice quality with influence on pusher block location. Thus, it is important to frequently inspect and regularly clean it.

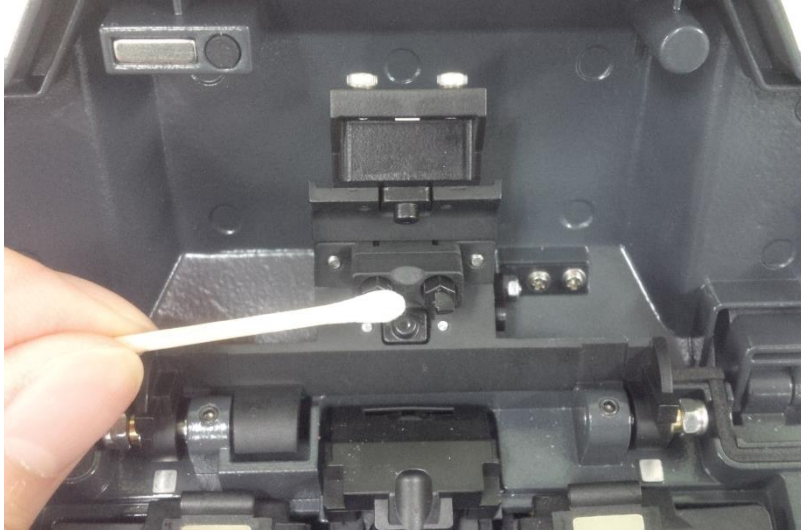

### 5.1.3 Cutter cleaning

When cutter's blade and fixing pad is contaminated, cutting quality may deteriorate. Splice loss can be consequently increased. Thus, clean the cutter blade and fixing pad frequently using cotton swab moistened with alcohol. It is critical to keep the cutting quality of optical fiber. (Do not use acetone or solvent when cleaning the rubber pad.)

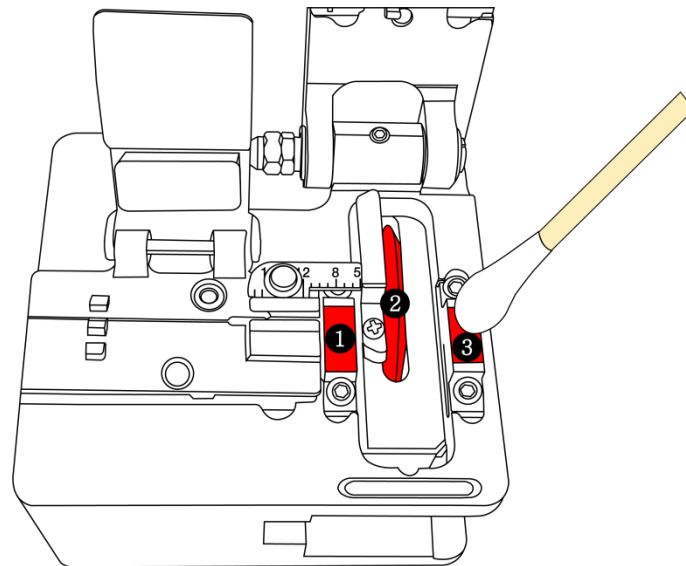

## 5.2 Regular cleaning and inspection

To keep sealer's splice quality, regular inspection and cleaning is required.

### 5.2.1 Object lens cleaning

Contamination on object lens' surface disturbs distinction of optical fiber core's location and consequently incurs high splice loss. Thus, 2 object lenses should be kept clean at all times. If dust accumulates and is left for long, it may be difficult to remove. Therefore, clean the lens frequently as follows.

- i. Turn the power off before cleaning the object lens.
- ii. Separate the electrode.
- iii. Clean it using a soft cotton swab moistened with alcohol making a circle from the center as in the figure below. Remove alcohol remaining on object lens' surface using a clean and dry cotton swab.

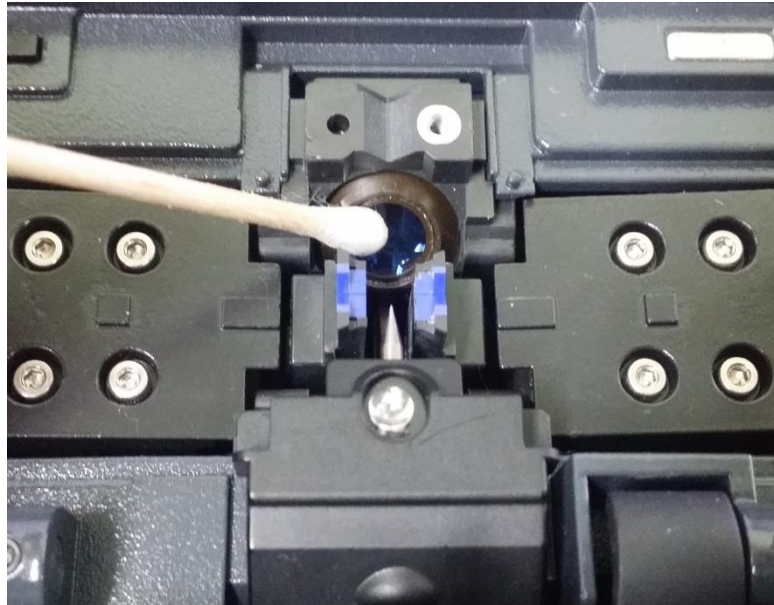

- iv. Surface of object lens should be clean without any line or stain.
- v. Reassemble the electrode.
- vi. Turn the power on; check whether there is any line or stain on the monitor and; conduct Self test.

## 5.2.2 Cutter blade rotation

When cutter fails to cut optical fiber properly, rotate the blade as follows.

- i. Unscrew the right and the left clamp screw using 1.5 hex key wrench.

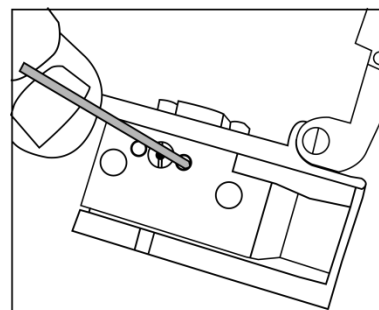
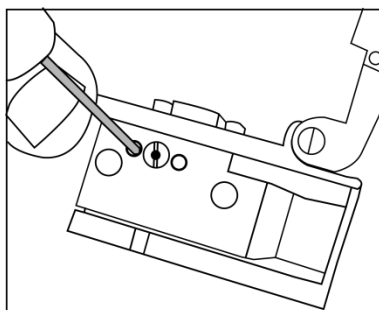

- ii. Rotate the blade one gauge only with a soft cotton swab. (Blade is of 16 gauges in total.)

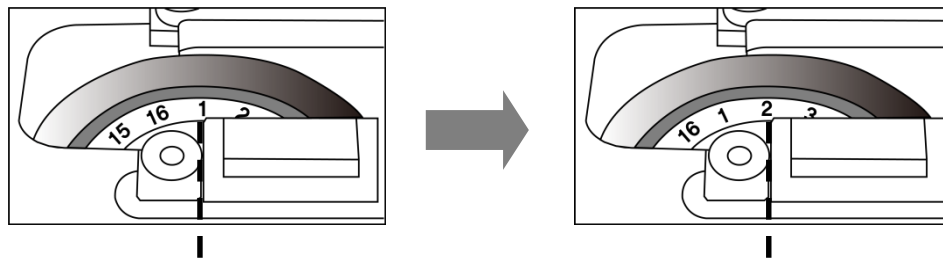
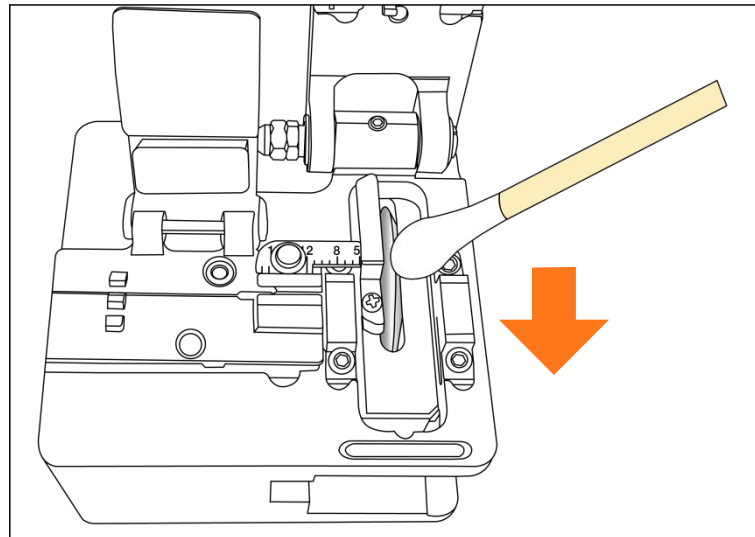

- iii. Tighten the right and the left clamp screw using 1.5 hex key wrench.

### 5.2.3 Electrode replacement

It is recommended to replace electrode after using 3,500 times. If the actual number of arc discharge exceeds the replacing cycle, a message for electrode replacement is displayed on the screen. Without electrode replacement, splice loss increases and tensile force at splicing point weakens.

- i. Turn the power off when replacing electrode.
- ii. Open the windbreak cover and unscrew the clamp screw of electrode block.



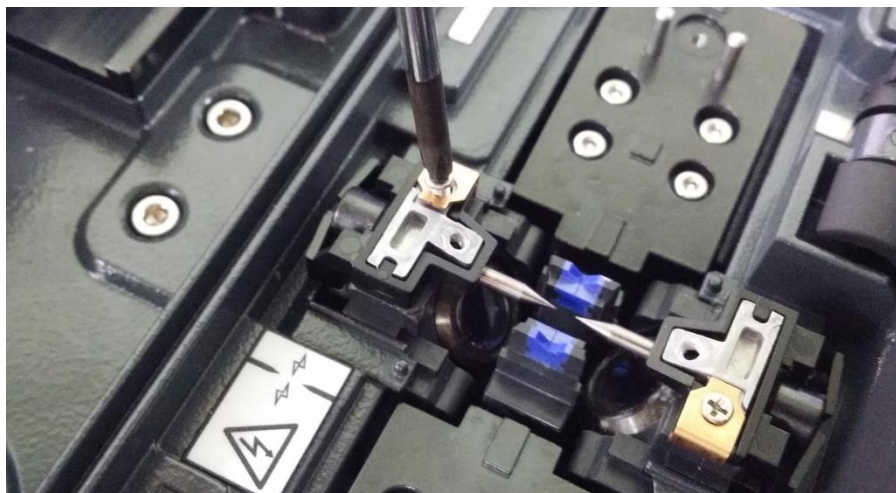

- iii. Remove the electrode block and the electrode.

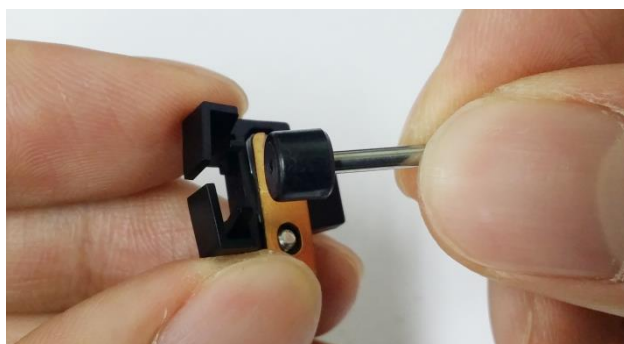

- iv. Clean the electrode carefully using soft cotton swab moistened with alcohol and then install it.
- v. Turn the power on and conduct electrode stabilizing.

## VI. Menu

Main menu has 8 submenus. Press **MENU** or touch the “MENU” icon on the screen to load main menu. The main menu screen is as follows. You can select right and left by pressing **HEAT** and **SET** buttons.

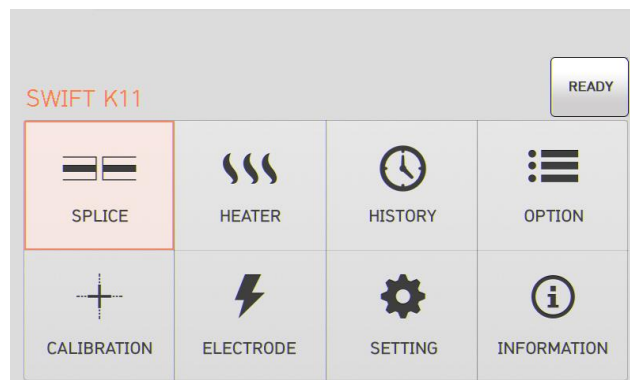

### ■ Sealing

- ✓ Delete: It deletes splice mode.
- ✓ Replace: It selects and replaces a certain splice mode within database.
- ✓ Add: It selects and adds a certain splice mode within database.
- ✓ Edit: It edits set values of splice mode.
- ✓ Select: It selects a splice mode to run.
- ✓ Close: It closes menu window.

### ■ Heater

- ✓ Delete: It deletes heater mode.
- ✓ Replace: It selects and replaces a certain heater mode within database.
- ✓ Add: It selects and adds a certain heater mode within database.
- ✓ Edit: It edits set values of heater mode.
- ✓ Select: It selects a heater mode to run.
- ✓ Close: It closes menu window.

### ■ Splice result

- ✓ Splice result display: It displays splice result and image.
- ✓ Delete splice result: It deletes all data.

## ■ Option

- ✓ Splice operation initial setting: Auto, Pause, Auto heater
- ✓ Menu lock: Menu lock setting
- ✓ Password: Password setting upon locking

## ■ Calibration

- ✓ Discharge amount calibration: It calibrates discharge intensity.
- ✓ Self test: It diagnoses equipment state.
- ✓ Motor operation: It operates motor manually.
- ✓ Motor calibration: It initializes motor's speed and location.

## ■ Electrode

- ✓ Electrode stabilizing: It conducts electrode stabilizing.
- ✓ Electrode caution: It sets the number of uses to inform when to replace electrode.
- ✓ Electrode replacement: It explains how to replace electrode.
- ✓ Number of using electrode: It displays the electrode use count.

## ■ Setting

- ✓ Language: It selects a language.
- ✓ Time: It sets the present time.
- ✓ Sleep: It sets sleep mode.
- ✓ Sound: It adjusts intensity of buzzer sound.
- ✓ LCD brightness: It adjusts brightness of the screen.

## ■ Information

- ✓ Maintenance: It displays maintenance schedule.
- ✓ Sensor: It indicates temperature, pressure and humidity.
- ✓ Version: It shows the current version of product.
- ✓ Help: It consists of the following.
  - Name of each part
  - Cleaning and Inspection
  - Cautions
  - Contact for A/S

## Popup Menu

Popup menu of Swift K11 has been changed to a new form. Purpose of popup menu is to facilitate easy and quick access to splice mode and heater mode. User can access popup menu in various ways.

### [Importing popup menu]

- i. Splice popup menu can import the current splice mode by pressing "SPLICE" icon on screen of initial state.



- ii. Heater popup menu can import the current heater mode by pressing "HEATER" icon on screen of initial state.

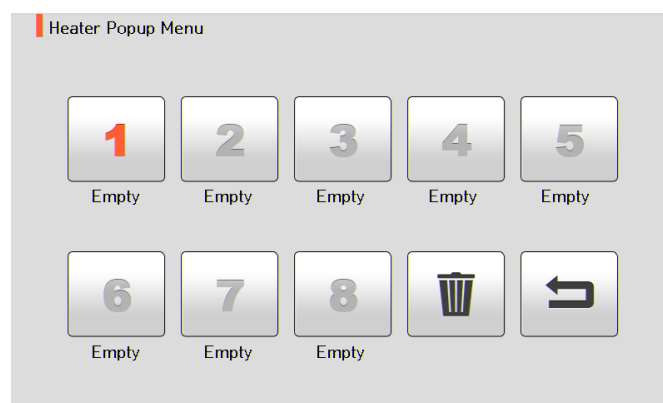

## [Splice popup menu]

### ■ Adding splice mode

- i. Import splice popup menu by pressing “SPLICE” icon on screen of initial state.

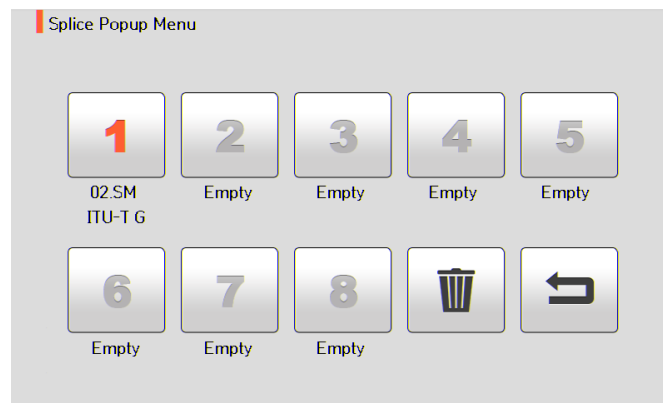

- ii. Select an empty slot by pressing touching the touch screen.

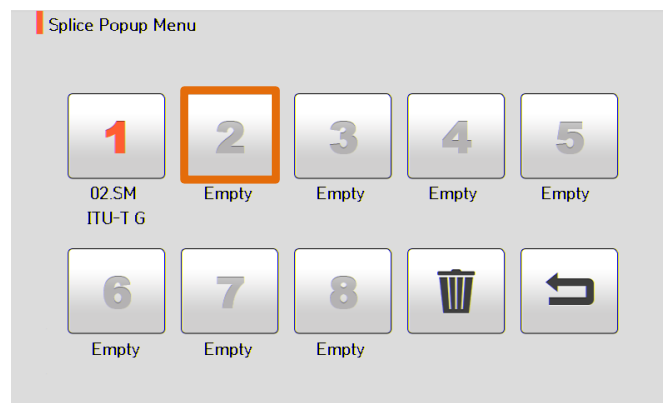

- iii. Select a splice mode to be put in the empty slot.

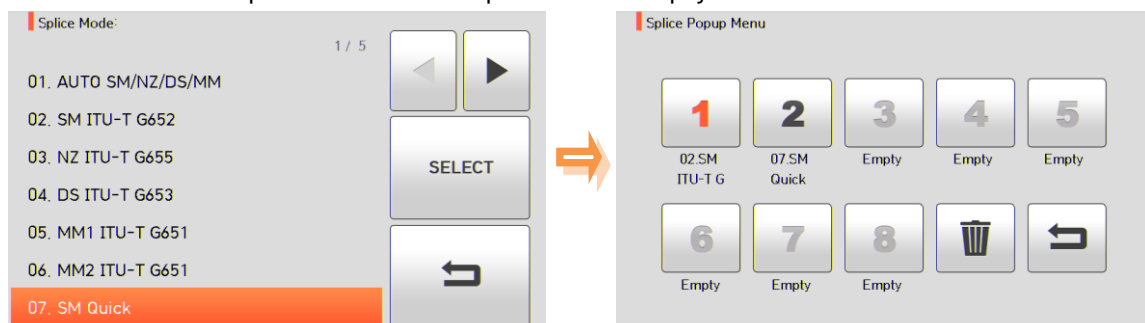

## ■ Deleting splice mode

- i. Delete a splice mode by touching .

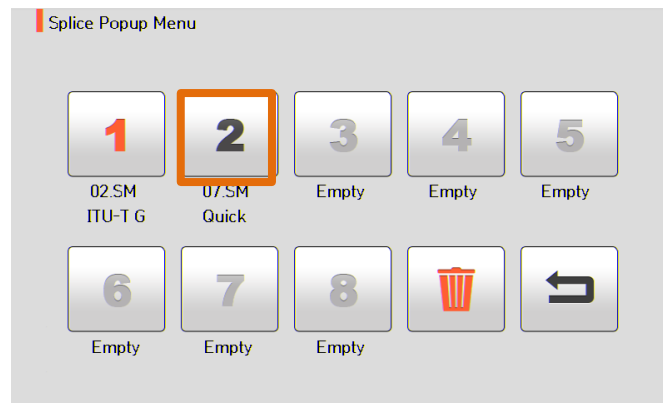

- ii. Select a mode to be deleted.



## [Heater popup menu]

### ■ Adding heater mode

- i. Import heater popup menu by pressing “HEATER” icon on screen of initial state.

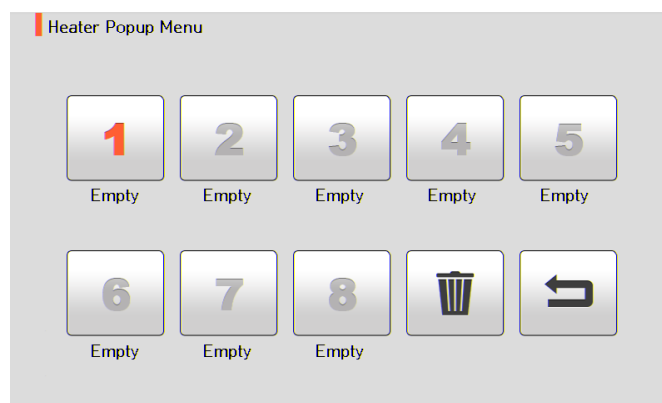

- ii. Select an empty slot by pressing touching the touch screen.

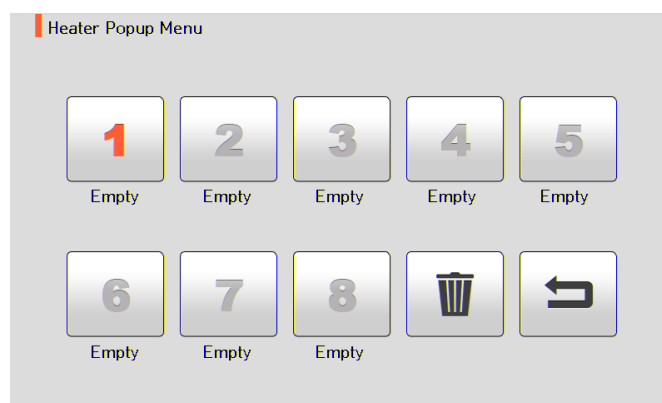

- iii. Select a heater mode to be put in the empty slot.

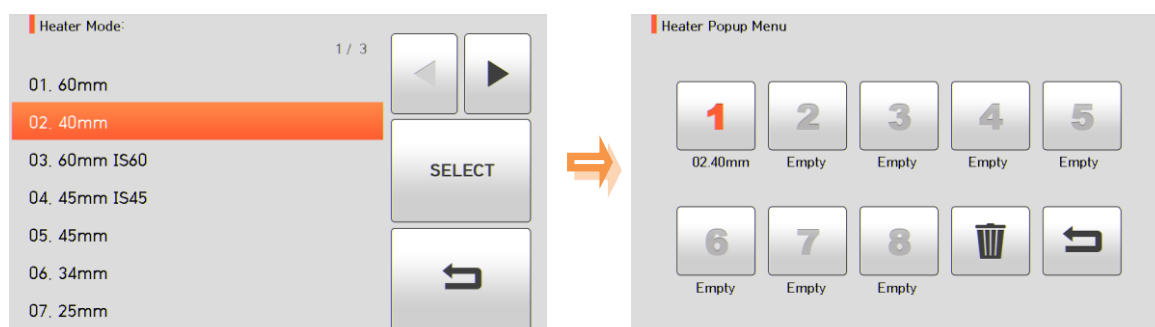

## ■ Deleting heater mode

- i. Delete a heater mode by touching .

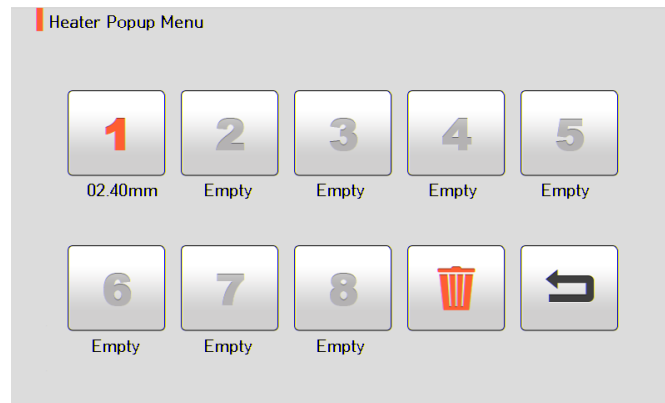

- ii. Select a mode to be deleted.

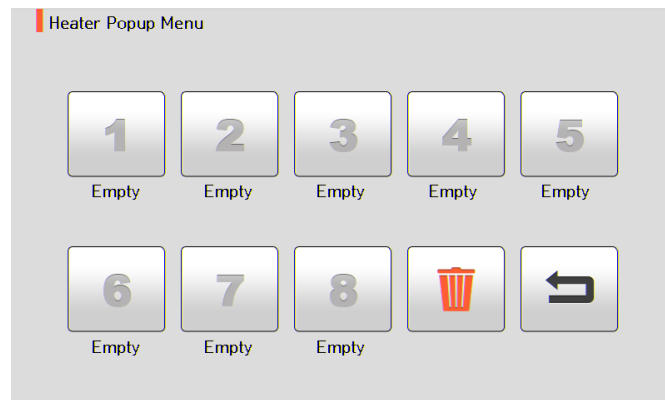



## 6.1 Splice

**MENU**

To import splice mode, press **MENU** and select “Sealing” menu by touch. It displays a screen to select splice mode as follows. The selecting screen is equipped with various splice modes to facilitate a user’s easy selection and use of splice mode. In addition, splice mode can be expanded and saved up to 300 units. These splice modes are classified into general mode and user mode.

- General splice mode: No. 1~32
- User splice mode: No. 33~300

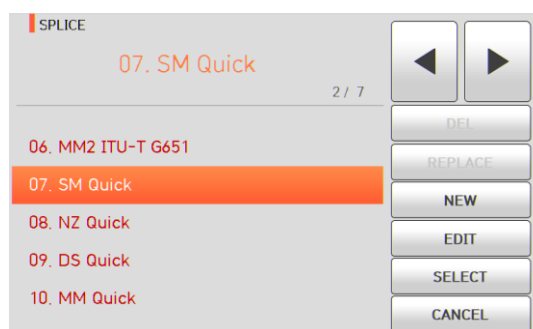
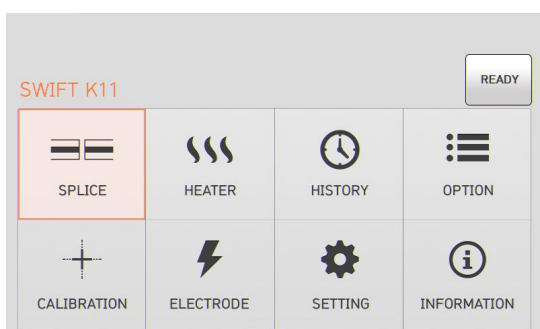

### [Outline of splice mode]

Splice mode	Description
SM	It is a mode for basic SM optical fiber. MFD of single mode optical fiber is about 9~10um at 1310nm wavelength.
NZ	It is a mode for NZDS optical fiber. MFD of NZDS optical fiber is about 9~10um at 1550nm wavelength. WDM optical fiber can also be spliced on this mode.
DS	It is a mode for DS optical fiber. MFD of DS optical fiber is about 7~9um at 1550nm wavelength.
MM	It is a mode for MM optical fiber. Core diameter of MM optical fiber is about 50~62.5um.
Other	Other splice modes are saved on database of Swift K11. New splice modes are currently being updated. Therefore, we recommend that users keep upgrading the equipment regularly by contacting Ilsintech.



### 6.1.1 Deletion

First, select a splice mode by touch. And then press “DEL” icon and the selected mode is deleted. General modes no. 1~32 cannot be deleted.

### 6.1.2 Replacement

Select a splice mode to replace by touch and press it, and splice modes saved on the database are displayed on the screen. Select a splice mode to replace and touch “REPLACE”, and the mode is replaced with the new mode.

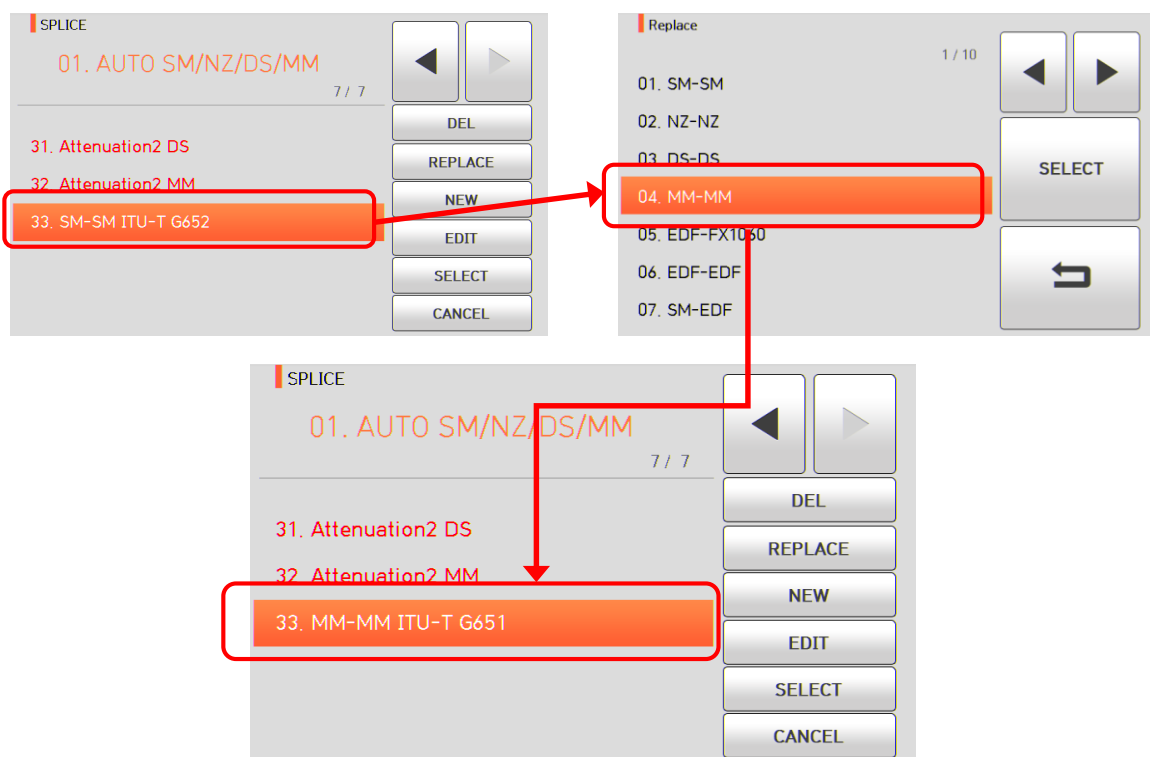

General modes no. 1~32 cannot be replaced.

### 6.1.3 Addition

Touch “NEW” icon and splice modes saved on the database are displayed on the screen. Select a splice mode to add and touch “SELECT” icon, and the mode is added. The mode newly added is located on the last number.

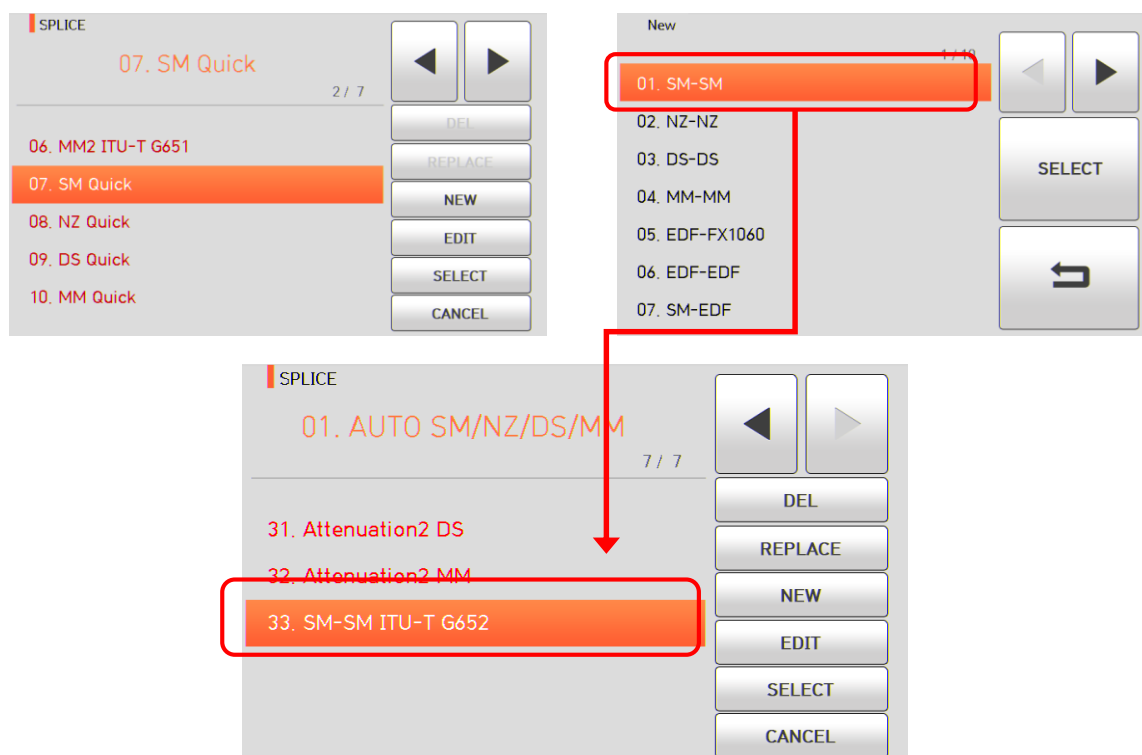

Addition cannot be made on general modes no. 1~32.

## 6.1.4 Edition

Select a splice mode to edit by touch and touch “EDIT” icon and different set values of the selected splice mode are displayed. Press a set value and change it into a proper one.

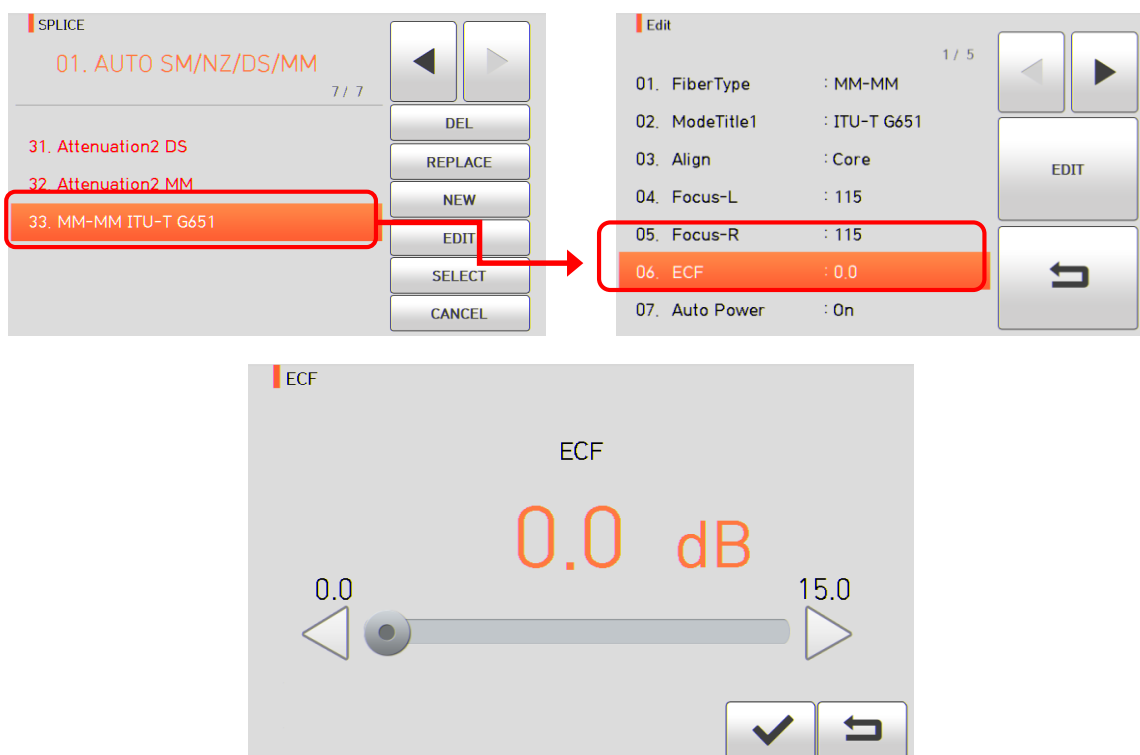

General modes no. 1~32 cannot be edited.

## [Set values editable within mode]

Set value	Description	General mode	User mode
Optical fiber type	It displays the list of splice mode saved on sealer data to facilitate selection of a proper mode to use. Among splice modes saved on database, it copies a similar splice mode to use editing function.	Editable	Editable
Mode title 1	Mode title 1 is to indicate splice mode within 11 letters at maximum.		
Eccentricity adjustment function	When arraying optical fiber by using eccentricity adjustment function, it sets offset ratio of axis.	Uneditabl e	
Automatic power	The closer it is arrayed to the core center with fewer errors, the quicker and better the discharge is done.		
Tensile force test	It conducts tensile force test after splice.		
Cutting angle limit	It sets cutting angle's error bound.	Editable	
	When either of cutting angles on both optical fiber is outside the bound, error message is displayed.		
Limit on estimated loss value	It sets estimated loss value's error bound.		
	When estimated loss is higher than the bound, error message is displayed.		
Limit on optical fiber angle	When the bending of 2 spliced optical fibers exceeds the set bound, error message is displayed.	Uneditabl e	
Cleaning discharge amount	A short cleaning discharge is conducted to remove fine dust on optical fiber's surface upon initial stage of optical fiber arrayal. It sets intensity of cleaning discharge.	Editable	
Cleaning discharge	It sets time for cleaning discharge.		
Clearance	Upon final arrayal, it sets clearance of cross section between both optical fibers.	Uneditabl e	
Clearance location	It sets location of optical fiber spliced at the center of discharge.		
		When MFD of both optical fibers differs, do the sealing procedure through melting the smaller MFD	

	<p>optical fiber more than the bigger MFD optical fiber. To heat the smaller MFD optical fiber more, splice loss can be lowered by moving the clearance location toward the bigger MFD optical fiber at the center of discharge.</p>	
Initial discharge amount	<p>It sets initial discharge amount from the beginning of discharge before optical fiber's advance. If the value of initial discharge amount is too low, the angle of optical fiber's cross section is poor and consequently, offset can be incurred on the axis and if it is too high, optical fiber can be burned too much or made round and consequently, splice loss value can be big.</p>	
Initial discharge time	<p>It sets initial time from the beginning of discharge before optical fiber's advance. If [initial discharge time] is long, it means the same that [initial discharge amount] gets big.</p>	
Overlap	<p>It sets duplication of optical fiber on optical fiber's advance amount.</p> <p>If [initial discharge amount] is weak or [initial discharge time] is short, set the [overlap] somewhat small and if discharge amount is strong and the time is long, set it somewhat big.</p>	
Discharge amount 1	<p>Main discharge can be adjusted in 2 levels.</p> <p>The first level of discharge is [discharge amount 1] and the second is [discharge amount 2]. [Discharge amount] 1 is set in this area.</p>	
Discharge time 1	<p>It sets time for [discharge amount 1].</p>	
Discharge amount 2	<p>[Discharge amount 2] is the second level of discharge. [Discharge amount 2] is set in this area.</p>	
Discharge time 2	<p>It sets time for [discharge amount 2].</p>	Editable
	<p>It sets time for [discharge amount 2]. [Discharge time 2] is generally set as "OFF."</p> <p>It can set the discharge time as a very long time period but when [discharge time 1] and [discharge time 2] exceed 30 seconds, electrode can be damaged.</p>	

Time period for discharge 2 being On	While [discharge amount 2] is on discharge, you can set the discharge amount as ON and OFF in turn. Time period for [discharge amount 2] being On is set in this area. For re-discharge, set the discharge time as "ON" at all times.		
Time period for discharge 2 being Off	It sets time period for discharge of [discharge amount 2] is turned off. When [discharge amount 2] is occasionally stopped, re-discharge can also be stopped. When re-discharge is continuously required, set as "OFF."		
Re-discharge time	It sets re-discharge time. Within [splice mode edition], it automatically sets to discharge the re-discharge amount with the same intensity as that of [discharge amount 2]. If [discharge amount 2] is set as ON/OFF, re-discharge is automatically changed.	Editable	
Pulling splice	When optical fiber is made thin, splice loss is sometimes increased. This pulling function is set as "OFF." The following 3 parameters decide the pulling shape.	Unedita ble	Editable
Pulling standby	It designates time period from the last of optical fiber advance amount to the beginning of pulling.		
Pulling speed	It sets optical fiber's pulling speed.		
Pulling length	It sets optical fiber's pulling time.		
Minimum loss	It is the sum of initially measured splice loss value and the increased loss. When splicing a special optical fiber or other optical fibers, high loss may be incurred in spite of the optimum discharge conditions. To match the estimated splice loss and the actual splice loss, the minimum value of actual splice loss should be set.		
MFD Left	mode field diameter Left		
MFD Right	mode field diameter Right		



## 6.1.5 Selection

Touch "SELECT" icon and the selected splice mode is saved on memory and it is used upon splicing.

## 6.1.6 Close

Touch "CANCEL" icon or press  and it goes back to the previous stage.

## 6.2 Heater

To import heater mode, press **MENU** and then select “Heater” menu by touching it. It displays a screen to select heater mode as follows. The selecting screen is equipped with various heater modes to facilitate a user’s easy selection and use of heater mode. In addition, heater mode can be expanded and saved up to 100 units. Heater mode no. 1~12 cannot be deleted, edited or replaced either.

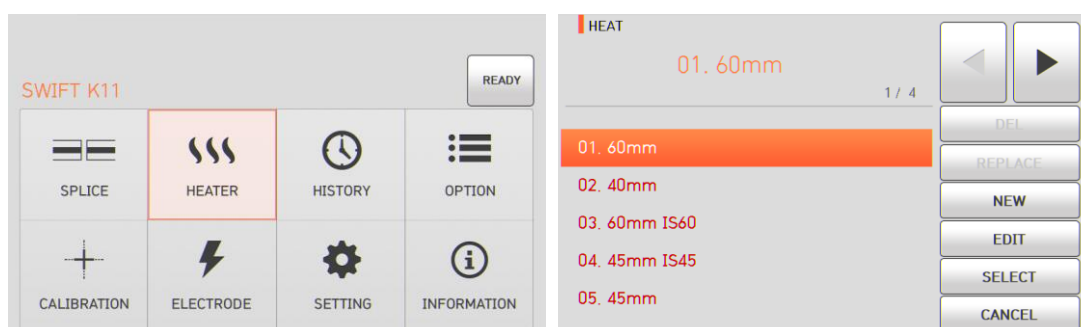

### [Outline of heater mode]

Set value	Description	Others
60mm	Standard 60mm micro sleeve	Sleeve type, mode title 1 and mode title 2 cannot be edited.
60mm IS-60	S-160 60mm micro sleeve	
45mm IS-45	S-145 45mm micro sleeve	
40mm	Standard 40mm micro sleeve	
S09	45mm sleeve	
S09-C	22mm sleeve for SOC(SC-0.9mm)	
S20	45mm sleeve for 2.0mm optical cable	
S30	32mm sleeve for SOC(SC-3.0mm)	
S30-C	32mm sleeve for SOC(SC-3.0mm)	
LC09/20-C	25mm sleeve for SOC(LC-0.9 and 2.0mm)	
ST09-C	28mm sleeve for SOC(ST-0.9mm)	
ST30-C	28mm sleeve for SOC(ST-3.0mm)	

## 6.2.1 Deletion

First, select a heater mode by touch. And then press “DEL” icon and the selected mode is deleted. General modes no. 1~16 cannot be deleted.

## 6.2.2 Replacement

Select a heater mode to replace by touch and press it, and heater modes saved on the database are displayed on the screen. Select a heater mode to replace and touch “REPLACE”, and the mode is replaced with the new mode.

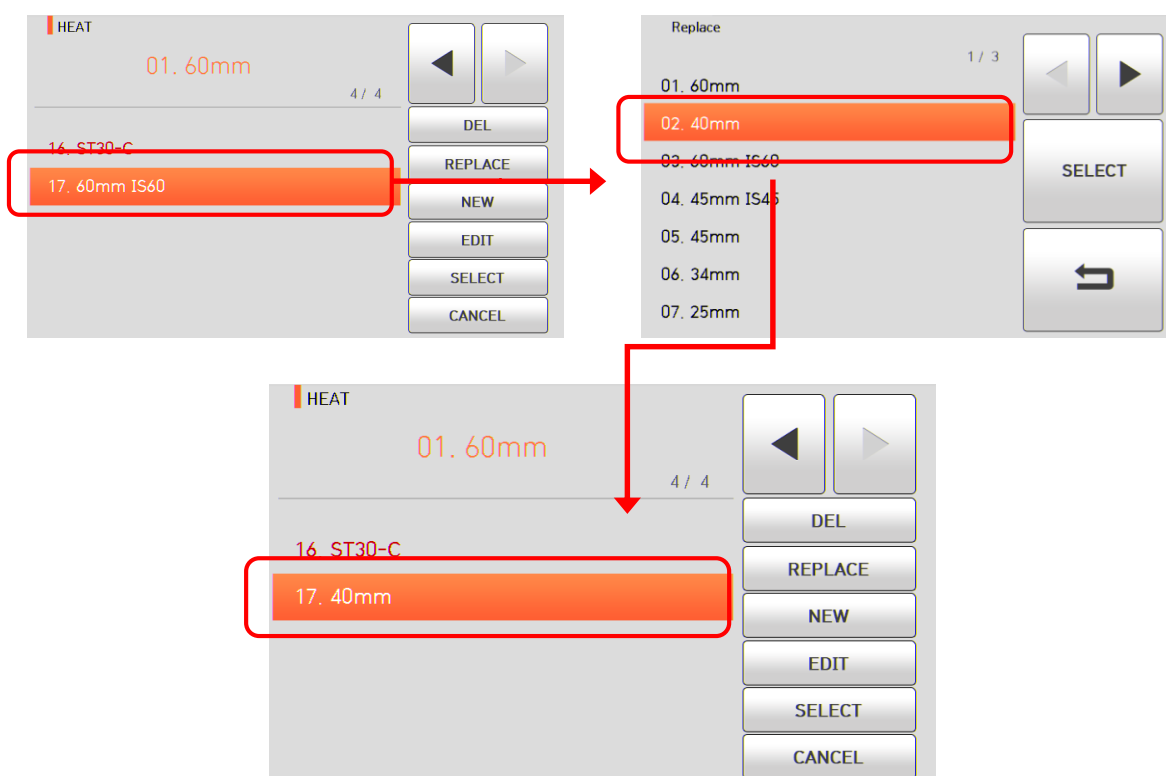

General modes no. 1~16 cannot be replaced.

### 6.2.3 Addition

Touch “NEW” icon and heater modes saved on the database are displayed on the screen. Select a heater mode to add and touch “SELECT” icon, and the mode is added. The mode newly added is located on the last number.

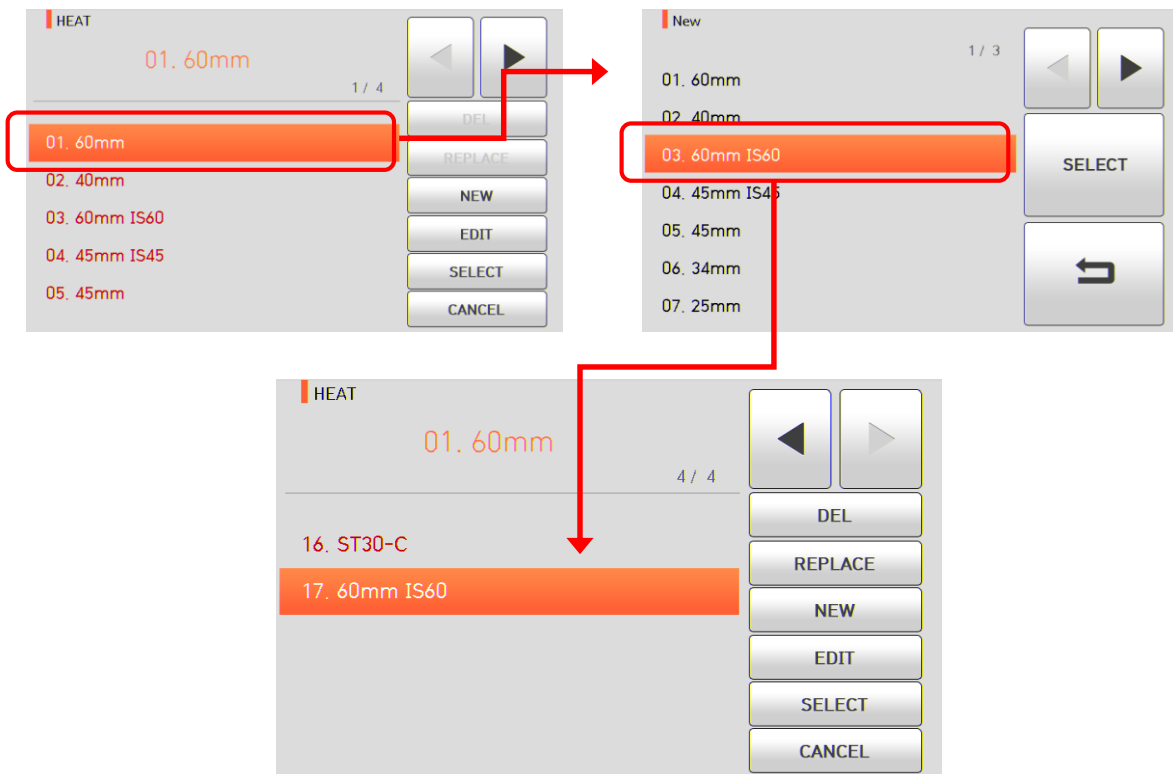

## 6.2.4 Edition

Select a heater mode to edit by touch and touch “EDIT” icon and different set values of the selected heater mode are displayed. Press a set value and change it into a proper one.

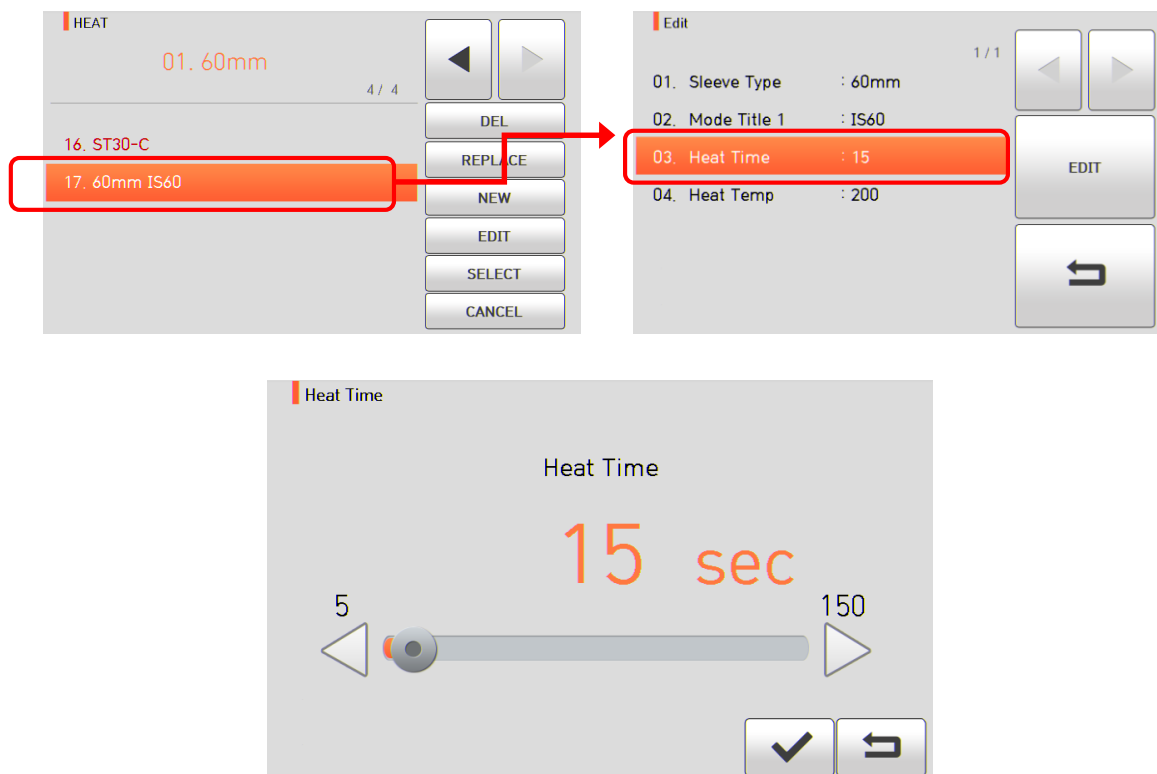

## 6.2.5 Selection

Touch “SELECT” icon and the selected heater mode is saved on memory and it is used upon operating heater.

## 6.2.6 Close

Touch “CANCEL” icon or press  and it goes back to the previous stage.

## 6.3 Splice result

To import splice mode, press **MENU** and then select “Splice result” menu by touching it. It displays a screen with splice result as follows. The splice result menu is equipped with various functions for a user to identify and delete splice result and image.

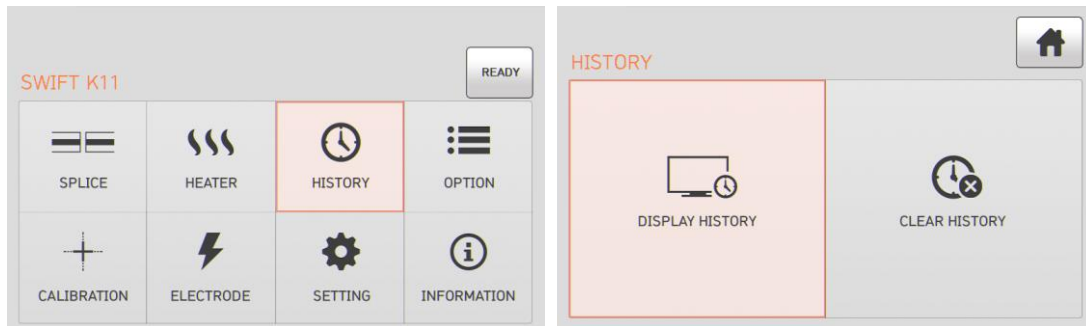

### 6.3.1 Splice result display

It can save up to 10,000 splice data and images and a user can identify them. Each page shows 500 splice data and images and it goes to the next page by pressing

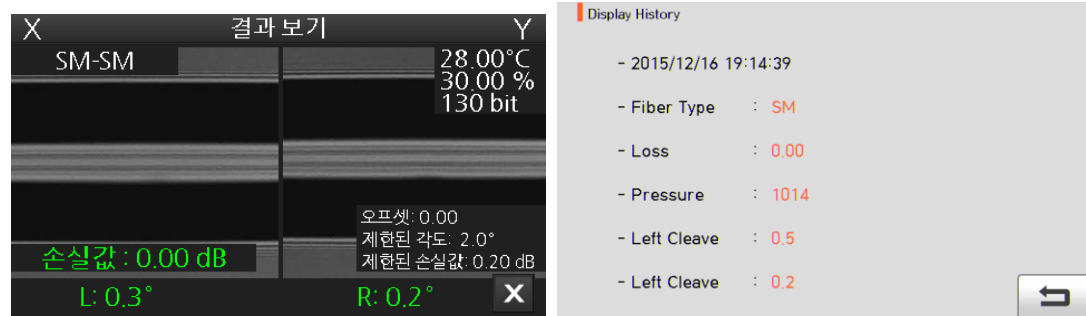
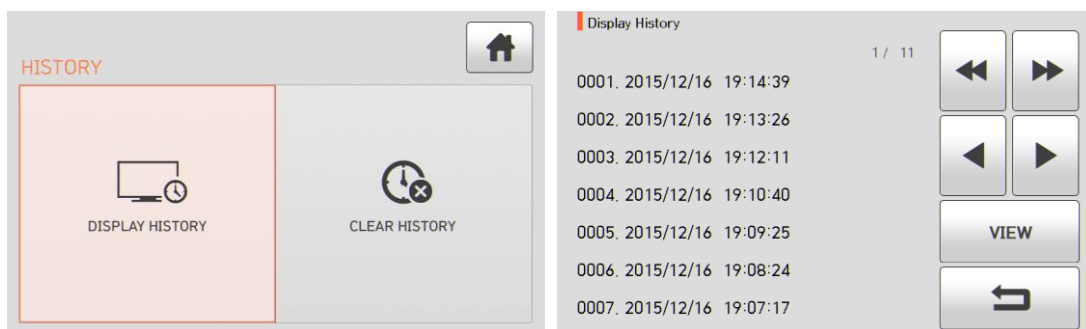

## 6.3.2 Deletion of splice result

The entire data and images can be deleted at a time.



## 6.4 Option

To import splice mode, press  and then select "Option" menu by touching it. It displays a screen to select option menu as follows. The option menu is equipped with various functions to provide a user with better service environment.

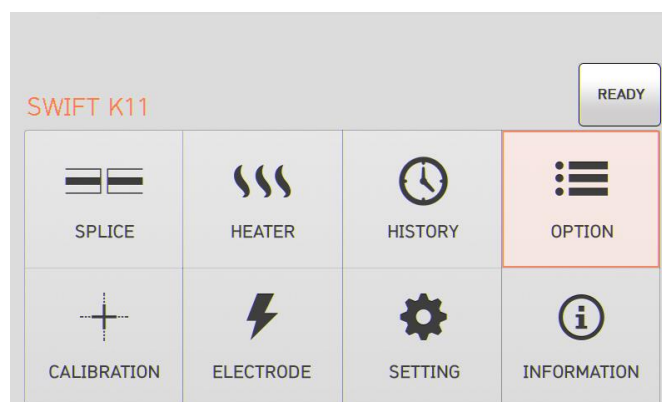

## 6.4.1 Splice operation

Splice operation consists of 4 sub-checkboxes. Check a checkbox and each function is activated.

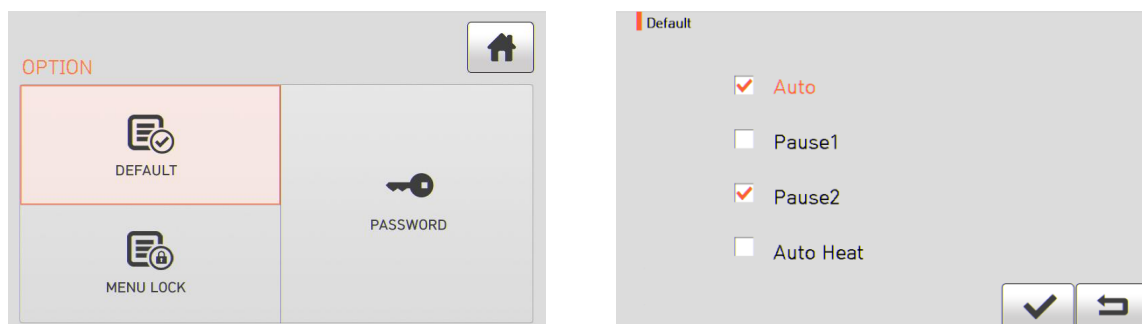

Set value	Description
Automatic	Splice automatically starts when closing the windbreak cover.
Pause 1	It temporarily stops after first arrayal completes. Press <b>SET</b> and it goes to the next step.
Pause 2	It temporarily stops after clad arrayal completes. Press <b>SET</b> and it goes to the next step.
Auto heater	After installing sleeve and closing the heater cover, the heater operates automatically.



## 6.4.2 Menu lock

This menu includes a function to restrict access to splice mode and heater mode setting and another function to disable deletion of splice result. After activating this lock function, even the access to menu for menu lock can also be restricted. Password entry is required to release this restriction so a user should memorize the password. If a user forgets the password, he should send the equipment to Ilsintech to reset the password.

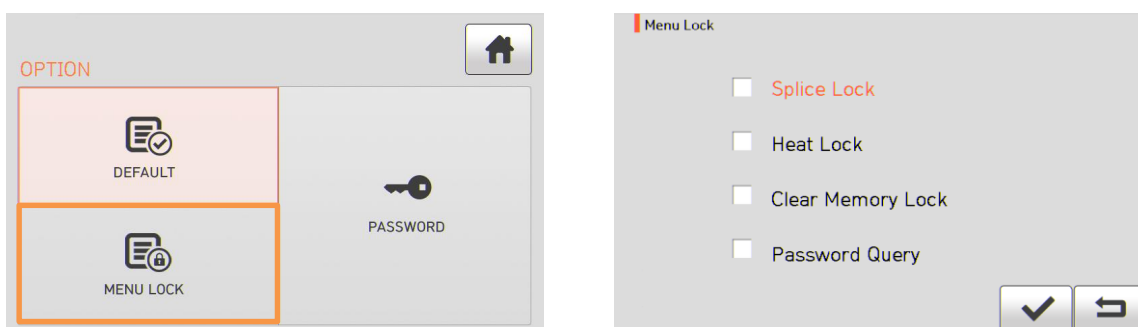

	Test item	Description
1	Splice mode lock	It restricts modification on splice mode.
2	Heater mode lock	It restricts modification on heater mode.
3	Lock on splice result deletion	It restricts deletion of splice result.
4	Password inquiry	It shows a screen to enter password. The initial password is "1234".

### 6.4.3 Password

Password can be changed as follows.

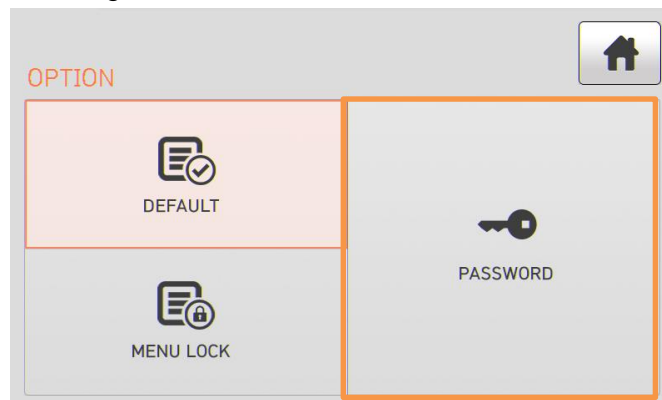

- i. Enter the current password.  
The initial password is "1234".

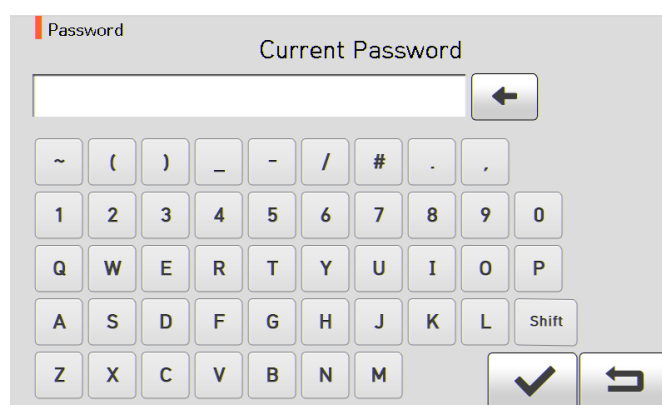

- ii. Enter a new password. The new password can be entered within 4 ~ 12 digits.



- iii. Enter the new password yet again.

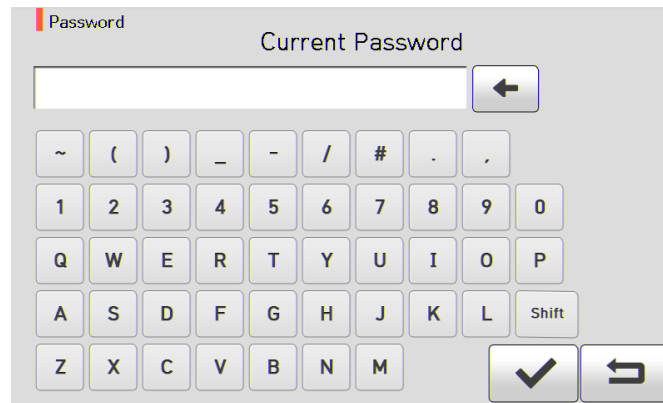

- When the entered password does not match, the following message is shown and it goes back to the previous stage.

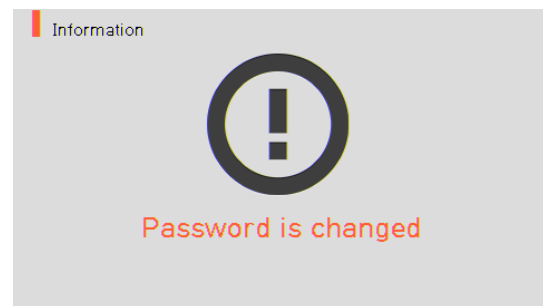
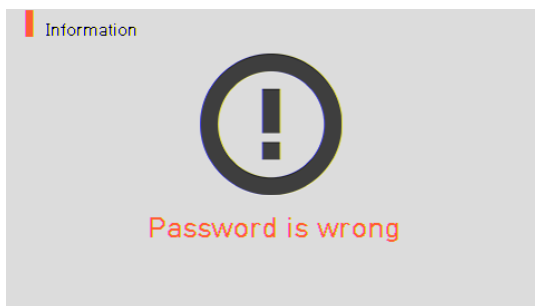

- A user should memorize the password. If a user forgets the password, he should send the equipment to IIsintech to reset the password.

## 6.5 Calibration

To import splice mode, press **MENU** and then select “Calibration” menu by touching it. It displays a screen to select calibration menu as follows. The calibration menu is equipped with various functions such as discharge amount calibration, motor operation test, etc.

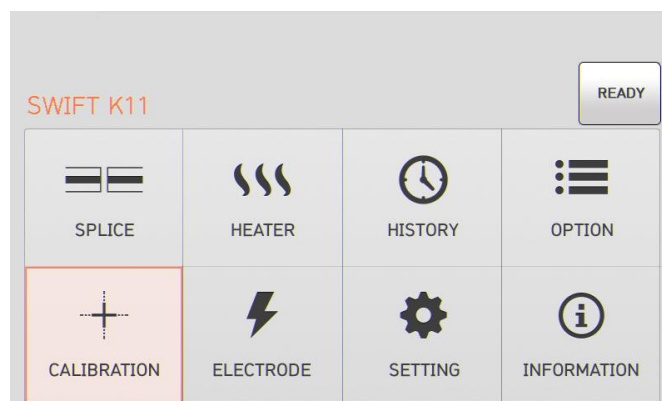

### 6.5.1 Discharge amount calibration

Swift K11 continuously checks change in temperature and air pressure through each sensor. Based on such data, discharge amount is automatically calibrated. Change in discharge amount due to electrode abrasion or optical fiber’s splice, however, is not automatically calibrated. The central axis of discharge can also be moved leftwards or rightwards with numerous discharge. In this case, discharge amount calibration is required.

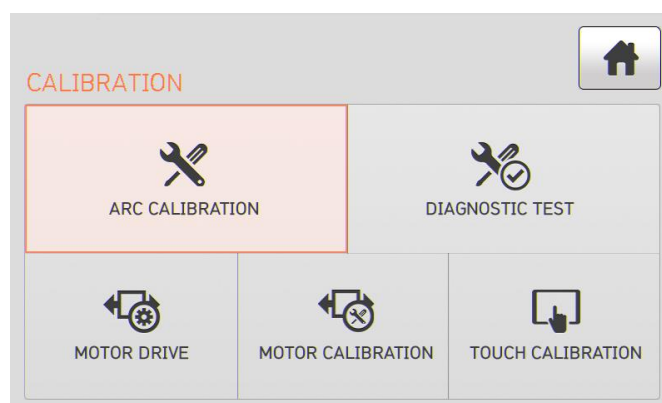

- When executing discharge amount calibration, discharge voltage is

automatically changed into a proper value. As this value is calculated by a certain computing program, a user cannot arbitrarily change it.

■ Upon discharge amount calibration, SM optical fiber should be used.

i. Put a prepared optical fiber on sealer.

ii. Press **SET** as follows.

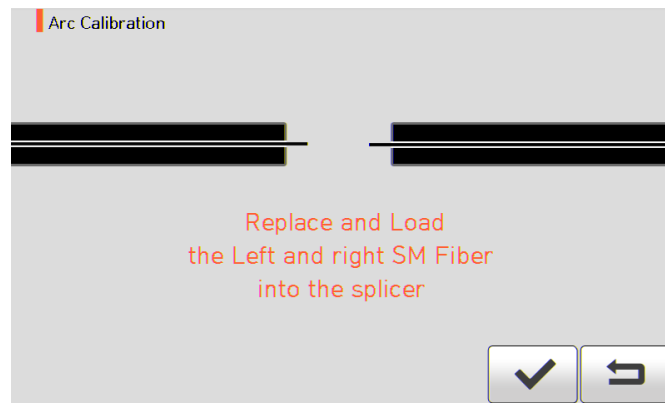

iii. When discharge amount calibration completes, the following screen is displayed.

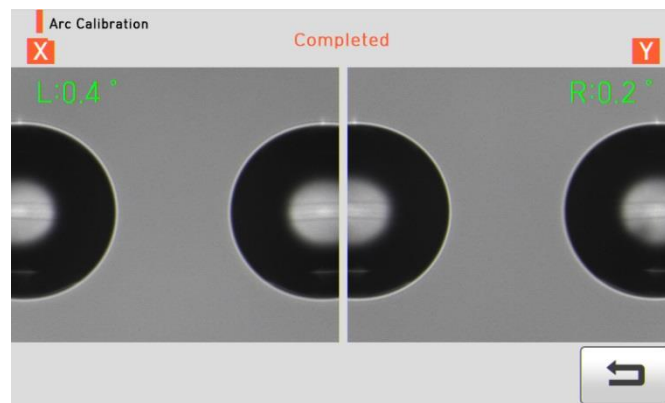

iv. Even before discharge amount calibration is completed, it immediately stops when pressing **RESET**.

## 6.5.2 Self test

Self test is a function to facilitate dust test, LED test and motor test and calibration at a time.

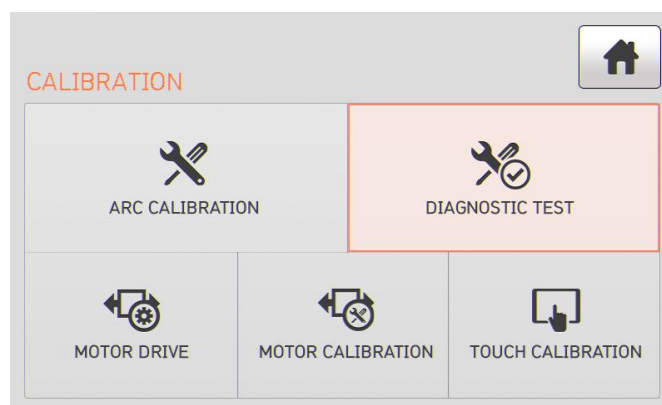



	Test item	Description
1	Dust test	It conducts dust test without optical fiber.
2	LED test	It conducts LED test without optical fiber.
3	Motor test	It conducts motor test without optical fiber.
4	Heater test	It conducts heater test without optical fiber.

### 6.5.3 Motor operation

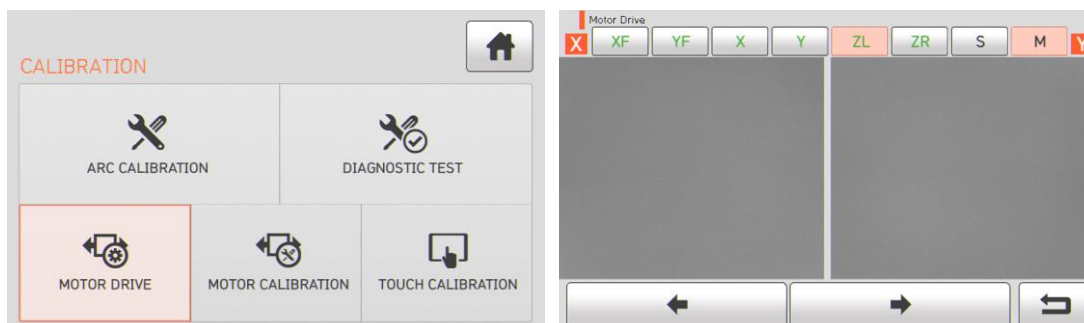
Motor operation checks whether the motor normally operates in manual mode.





- i. Remove optical fiber from sealer.
- ii. Select “Motor operation” by touch.
- iii. Change the motor selection by touching the icon at the top. The name of selected motor is indicated at the top of the screen.
- iv. Operate the motor in a direction wanted by touching arrow icons at the bottom.

Motor		
ZL/ZR	It makes ZL/ZR advance forward.	It makes ZL/ZR go backward.
S	It moves step by step upon every press of the button.	
M	It continuously moves upon pressing the button.	

## 6.5.4 Motor calibration

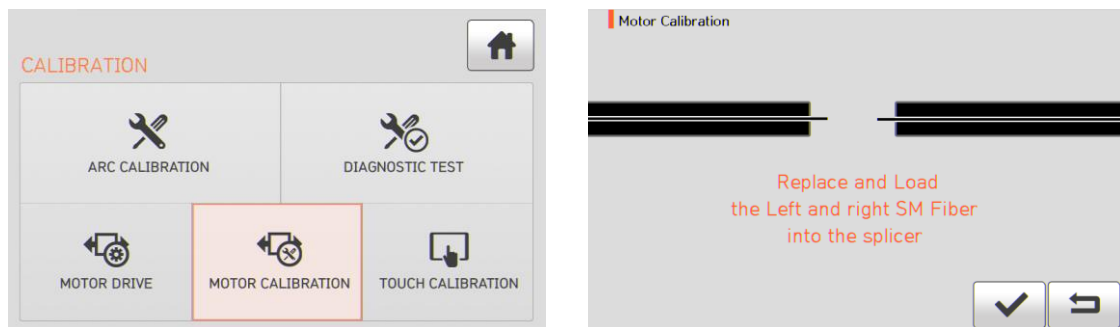
Motor setting is set on sealer as default but depending on motor setting location, splice speed may slow down. If speed slow down during the splice operation or any abnormality is incurred on entering position, motor setting can be automatically calibrated through this function.



- i. Put optical fiber on sealer.
- ii. Select “Motor calibration” by touching it.
- iii. If an error message is displayed after testing, contact to Ilsintech immediately.
- iv. End the calibration by pressing  .

## 6.5.5 Touch screen correction

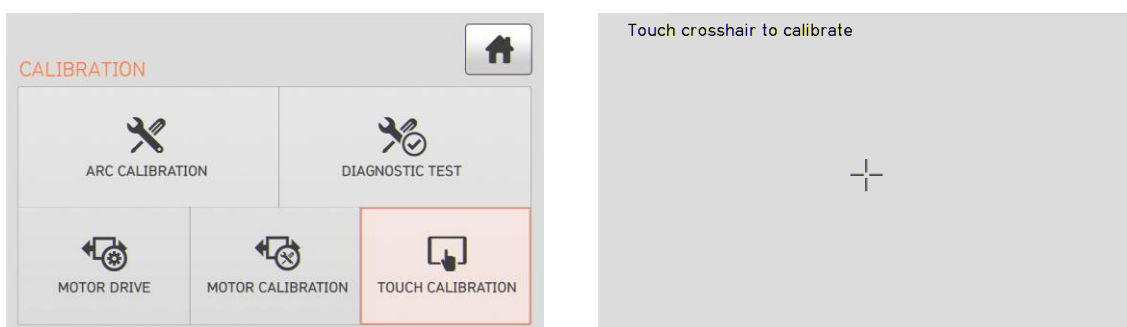

When touch screen does not operate at a normal position, a user can calibrate the touch screen.

The location of touch is to be calibrated by touching the cross indicated.



## 6.6 Electrode

To import splice mode, press **MENU** and select “Eletrode” menu by touch. It displays a screen to select electrode menu as follows. For using the sealer, it should be regularly cleaned due to electrode abrasion and precipitation of silica oxide. This menu is related to checking electrode use count and electrode exchange and includes 4 submenus.

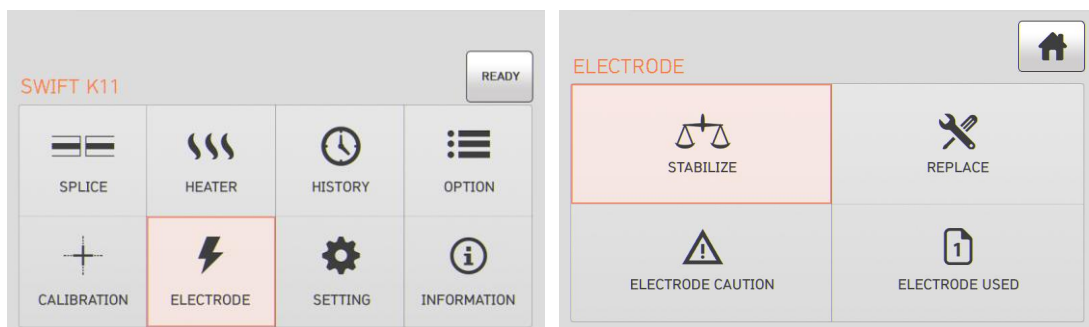

## 6.6.1 Electrode stabilizing

Discharge amount can sometimes become unstable due to surroundings and consequently, the splice loss may increase. As it takes a long time to stabilize discharge amount when the sealer is located low or high, it is particularly important to wait for the electrode inside the case to be stabilized. After replacing electrode, in particular, its stabilizing should be conducted without fail.

- i. Put a prepared optical fiber on sealer.
- ii. Select "Electrode stabilizing" by touching it.

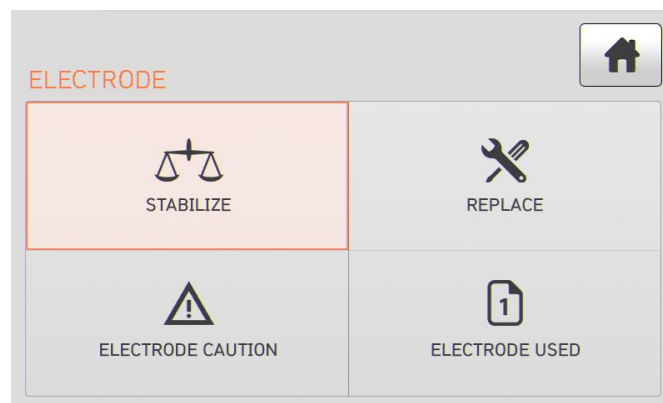

- iii. Press "OK".

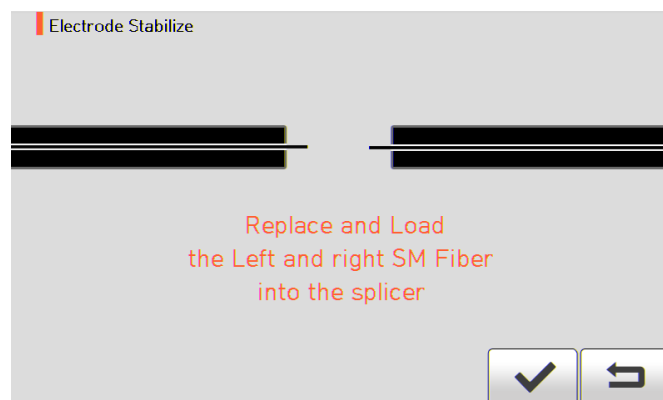

- iv. Discharge is conducted 30 times in a row for electrode stabilizing.
- v. When stabilizing completes, it displays the screen below.

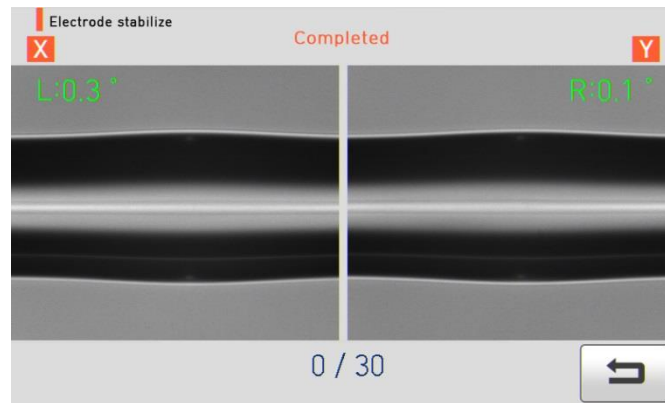

- vi. After electrode stabilizing, discharge amount calibration should additionally be conducted yet again.

## 6.6.2 Electrode replacement

It is recommended to replace an electrode when the number of discharge reaches 3,500 times. When it exceeds the preset number of times for replacement, a message informing electrode replacement is displayed.

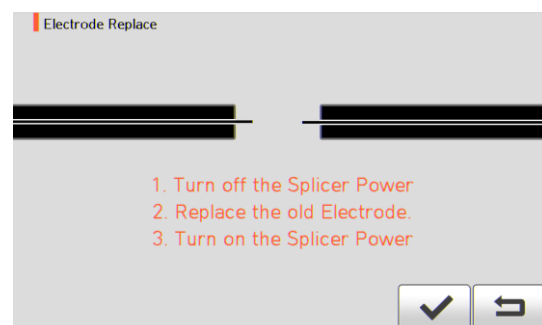
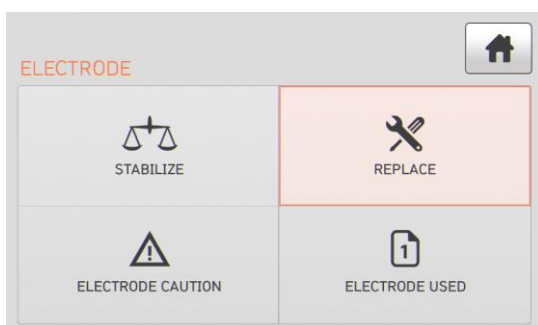

### 6.6.3 Electrode caution

The number of times to inform electrode replacement is set on this menu. It is recommended to replace an electrode when its use reaches 3,500 times.



### 6.7.4 Number of electrode use count

It indicates the number of electrode use count up to the present time.

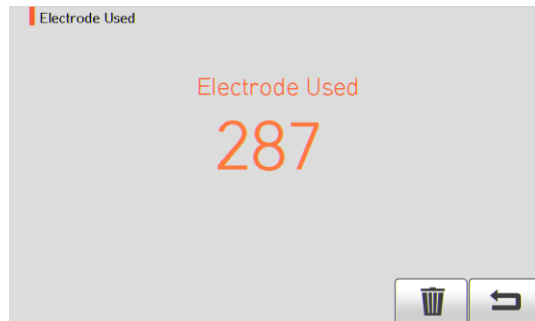

## 6.7 Setting

To import splice mode, press **MENU** and then select “Setting” menu by touching it. It displays a screen to select setting menu as follows.

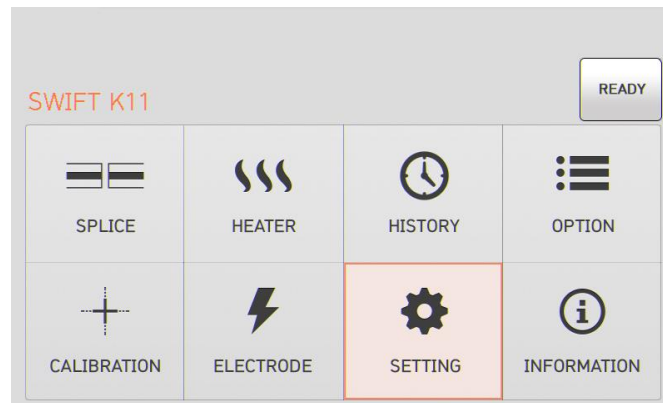

### 6.7.1 Language

A screen to select language is displayed.

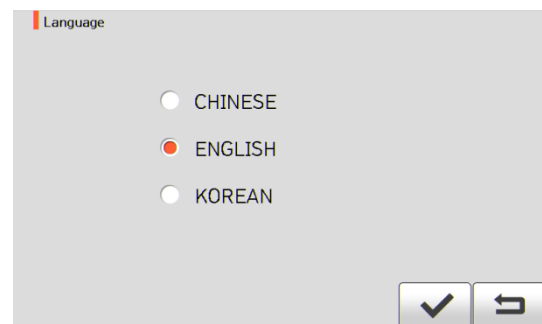
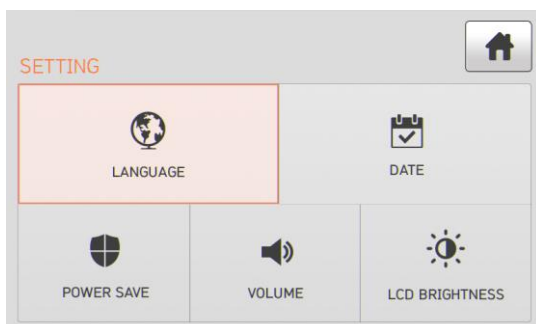

## 6.7.2 Time

A screen to set time and date is displayed.

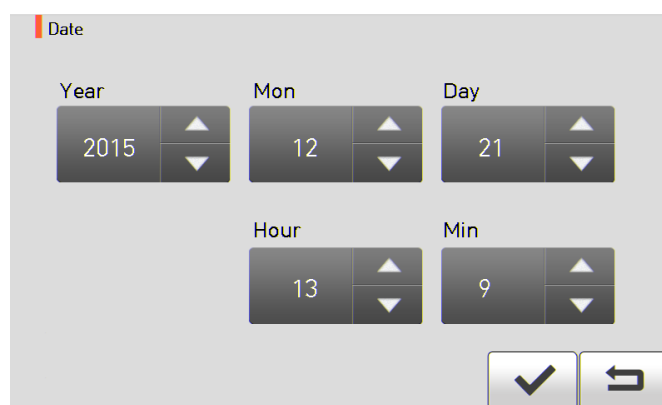
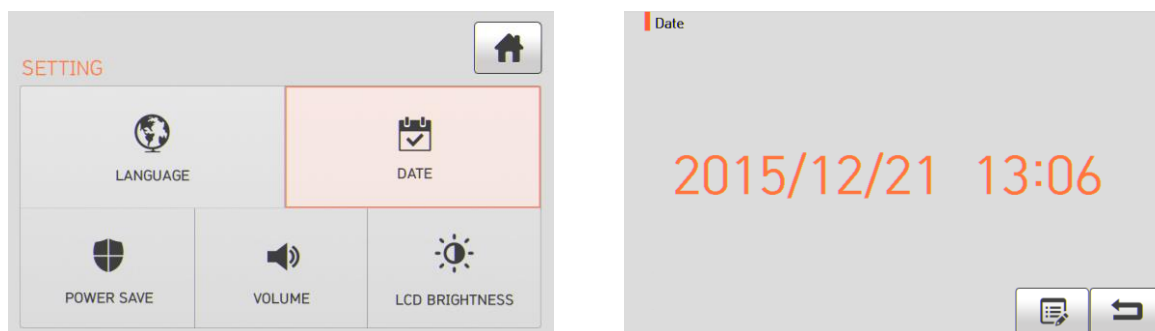

## 6.7.3 Sleep mode

Sleep mode is an important function to save energy. As it extends a user's operation time when operating Swift K11 with battery, it is recommended to use.

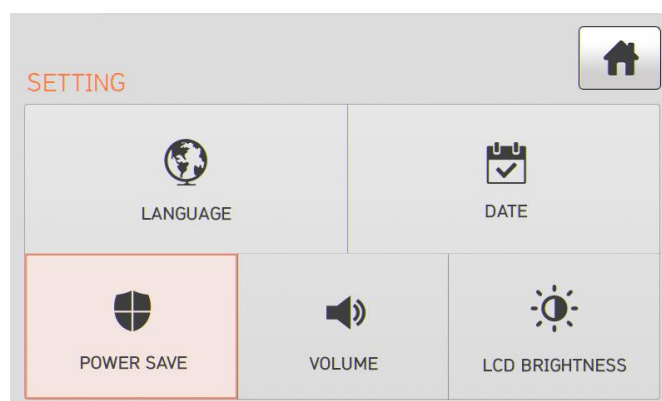

### 6.7.3.1 Monitor

When Swift K11 is not used for a preset time period, LCD screen is automatically turned off. Push any button and the screen is turned on again.

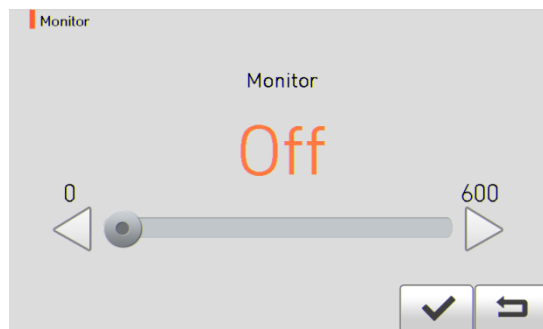

### 6.7.3.2 Splicer

When Swift K11 is not used for a preset time period, power is automatically turned off.

The power is turned on again only when pressing .

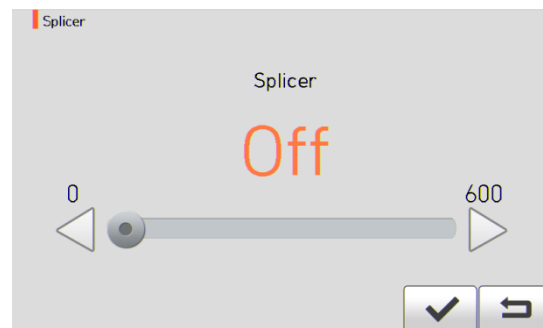
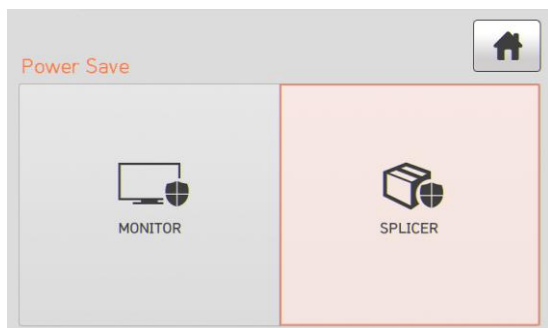

## 6.7.4 Sound

It adjusts intensity of buzzer sound.

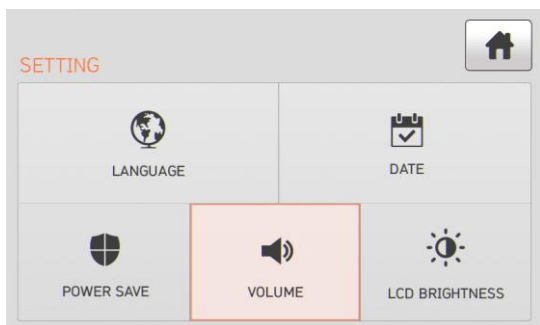

## 6.7.5 LCD brightness

It adjusts brightness of LCD.

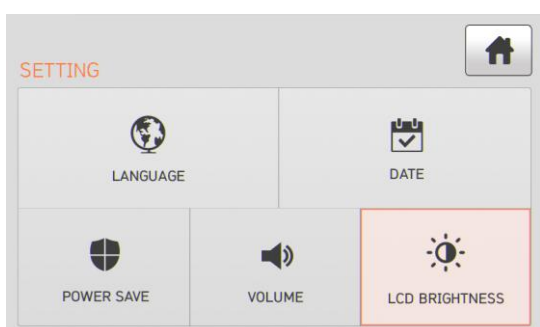



## 6.8 Information

**MENU**

To import splice mode, press **MENU** and select “Information” menu by touch. It displays a screen to select information menu as follows. This menu provides information for maintenance.

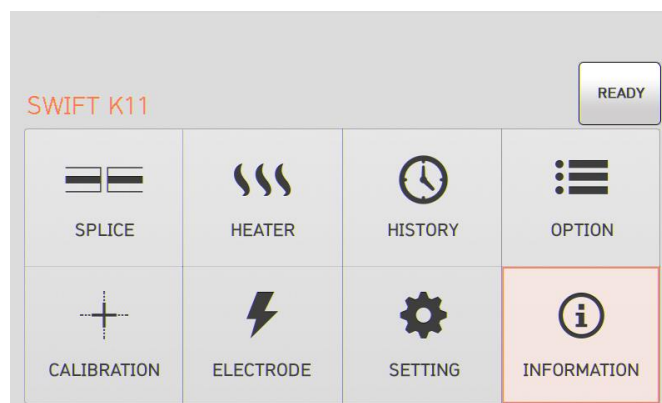

### 6.8.1 Maintenance

Press “Maintenance” and it displays the screen below.

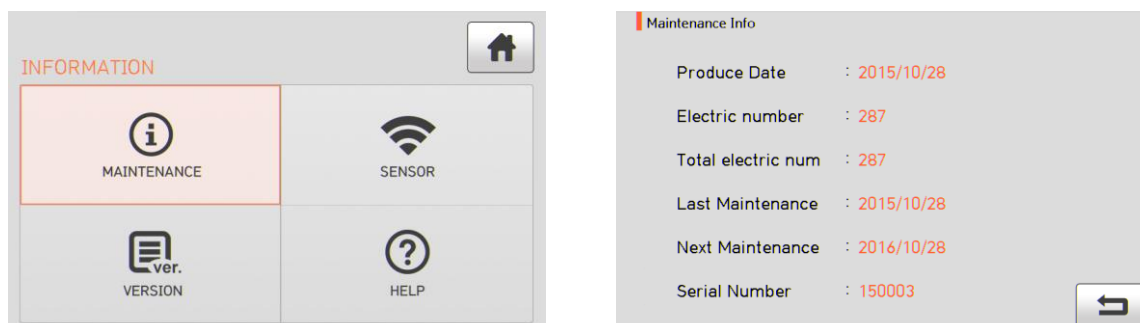

Item	Description
Date of manufacture	It describes the date of equipment’s manufacture. (year, month, day)
Number of discharge	It indicates the number of discharge after electrode replacement.
Total number of discharge	It indicates the total number of discharge after the product’s release.
Last maintenance	It indicates the date of recent maintenance.
Next maintenance	It indicates the next maintenance date.
Serial number	It indicates serial number given to the equipment.

## 6.8.2 Sensor

Press “Sensor” and it displays the screen below.

Sealer has sensors to check temperature, air pressure and voltage.

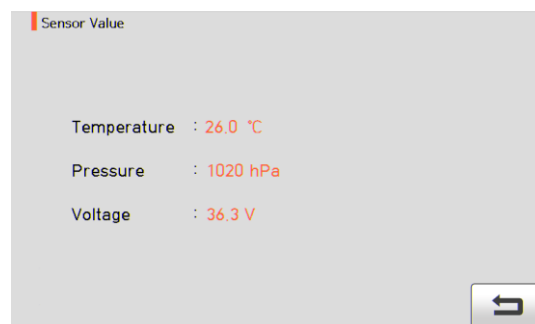
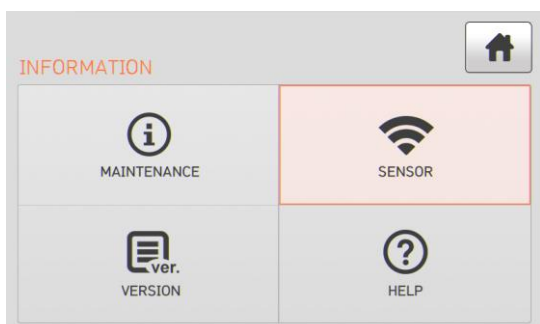

## 6.8.3 Version

Press “Version” and it displays the screen below.

The version can be easily upgraded by connecting to PC and using DataSync program (PC Program).

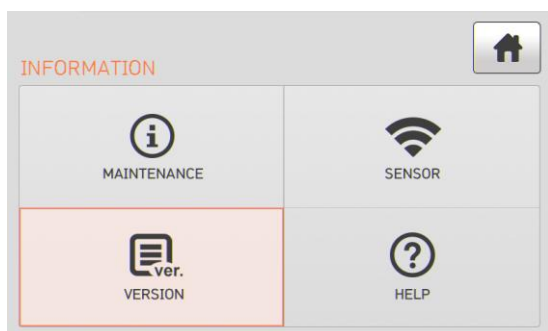

## 6.8.4 Help

Press “Help” and it displays the screen below.

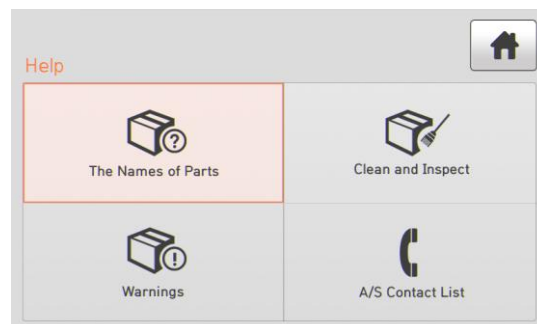
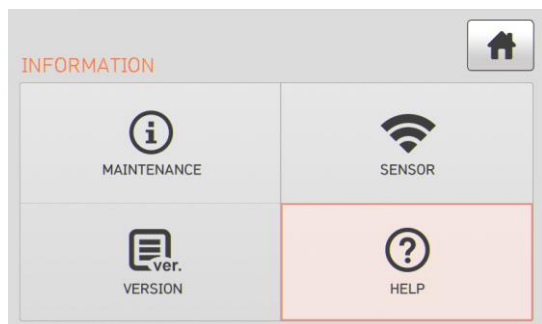

Item	Description
Name of each component	Names of each component on Swift K11
Cleaning and Inspection	Cleaning and inspection method
Warnings	Important warnings
Contact for A/S	Contact information for A/S

## VII. Error message

### 7.1 Optical fiber is too dirty.

It is an error message generated when the optical fiber prepared for sealing is with foreign substances exceeding a normal level.

Solution: Do splice again after cleaning the optical fiber.

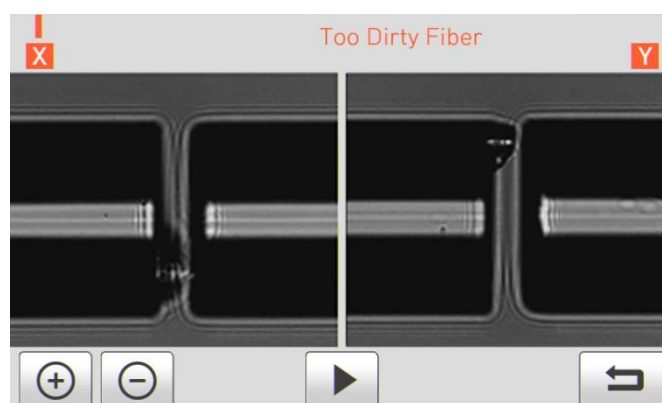

### 7.2 Replace the optical fiber.

It is an error message generated when the optical fiber is not located on a right location or there is a foreign substance on object lens or reflector.

Solution: Press **RESET** and put the optical fiber on a right location yet again. Clean the object lens and reflector.

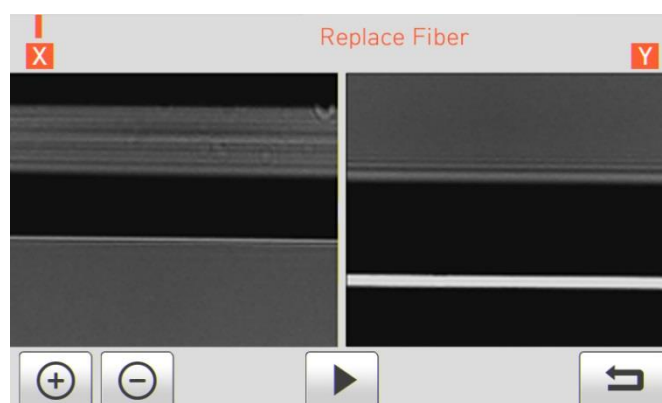

### 7.3 Optical fiber is too long.

It is an error message generated when optical fiber is located too close to the electrode; object lens or reflector is dirty or; LED is not sufficiently bright.

Solution: Press **RESET** and put the optical fiber on a right location yet again. Clean the object lens and reflector. Conduct LED test. If an error occurs upon LED test, contact to IIsintech.

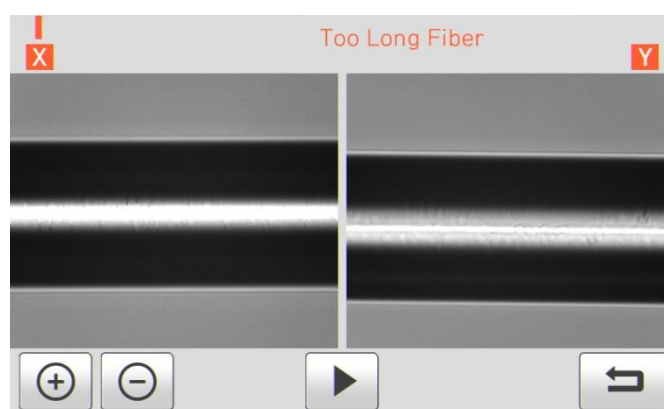

### 7.4 Error on angle of optical fiber

It is an error message generated when cutting angle of optical fiber is measured bigger than the limit.

Solution: Check the state of optical fiber cutter. Check the cutting angle limit.

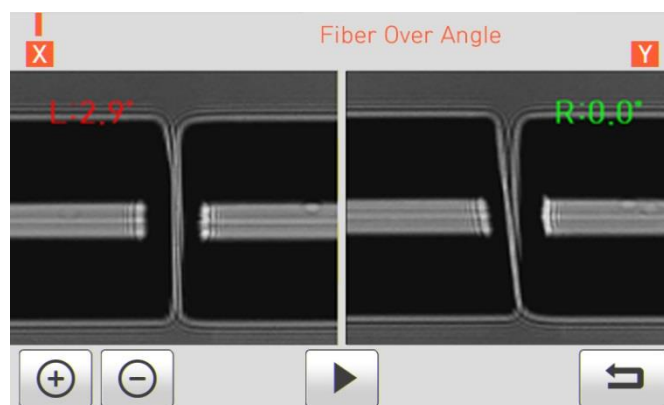

## 7.5 Loss is big.

It is an error message generated when estimated loss value is bigger than the preset loss factor limit.

Solution: Check the loss factor limit.

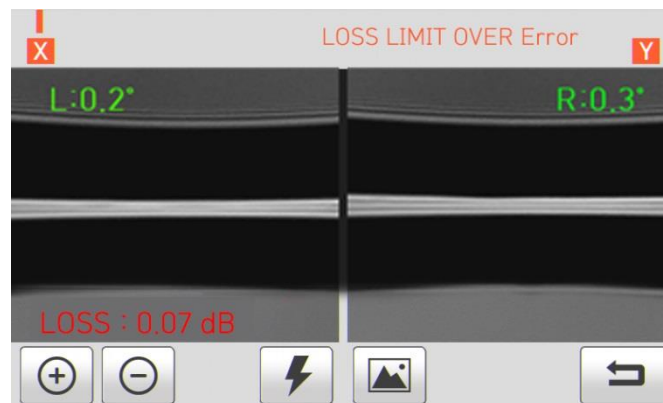

## 7.6 Optical fiber is thin.

It is an error message generated when optical fiber sealing part becomes thinner than the standard after sealing.

Solution: Make adjustment to shorten the pulling length of pulling splice. Check whether discharge amount or discharge time is set as too big or too long respectively.

## 7.7 Optical fiber is thick.

It is an error message generated when optical fiber sealing part becomes thicker than the standard after sealing.

Solution: Reduce the overlap set value. Check whether discharge amount or discharge time is set as too small or too short respectively.

## **7.8 Bubble being generated**

It is an error message generated when there are bubbles or spots being generated on optical fiber sealing part after sealing.

Solution: Examine the optical fiber cutter. Clean the V-Groove. Examine the electrode.

## **7.9 Error on cut surface on left, right or both**

It is an error message generated when the cut surface of optical fiber is of poor quality.

Solution: Check the state of optical fiber cutter. Cut the optical fiber yet again.

## VIII. Sealing problem solving

---

### 8.1 When loss is big

- Any dust or foreign substance on optical fiber's surface may incur poor splice.
  - Clean the optical fiber's surface sufficiently.
  - Do not clean the optical fiber after cutting to prevent dust from being gathered on optical fiber's cross section.
  - Do not push in the optical fiber when putting it on V-Groove. Optical fiber should be placed from top to bottom.
  
- Any foreign substance on V-Groove hinders right arrayal.
  - Keep the V-Groove clean at all times.
  
- Electrode being poor
  - When an electrode is of abrasion or its tip is bent and dirty, replace the electrode.
  
- Discharge amount and discharge time are inappropriate.
  - Check the setting of discharge amount and discharge time to reset them with proper values.
  - Without any great change, the initially set values are the most appropriate ones.
  
- Inappropriate splice mode
  - Check whether a splice mode is selected appropriate for the optical fiber.



## 8.2 Abnormal sealing operation

- Arrayal operation is repeated.
  - Open the windbreak cover again and then close.
  - If the phenomenon continues, open the windbreak cover, press  and then turn off the power. And contact to Ilsintech.
  
- The error message “Optical fiber is too long” is continuously generated.
  - Turn off the power and contact to Ilsintech.

## IX. Problem occurrence and question

---

### 9.1 Power



- Power is not turned on by pressing  .
  - Check whether the screen is turned off with the switch being pressed for about 1 second.
- Splice can be done several times even with the fully charged battery.
  - Power is quickly consumed when sleep mode is not in use. Refer to the [sleep mode] and use the power appropriately at all times. When the battery is kept for long, recharge it.
  - If the battery's life ends for long-term use, replace it with a new one. As the battery operates using chemical reaction, its wattage drops with low temperature and it rapidly drops particularly with temperatures below zero. As the splice current consumption goes up with high temperature, battery's power consumption accelerates.
- LED is not turned on upon charging.
  - Disconnect the charger's AC power cord and connect the DC cord to the charging jack.  
Connect the AC power cord after 10~15 seconds. Then the battery's LED is turned on red and charging starts.
- Remaining battery is not indicated.
  - Charge the battery.
- Remaining battery is not well displayed.
  - Remaining battery display is for reference.

## 9.2 Splice

- Error message is displayed on the screen.
  - Refer to the [Error message list].
  
- Splice loss is high or irregular.
  - Clean V-Groove, V-Block, reflector and object lens by referring to [Maintenance of splice quality]. Replace electrode by referring to [Electrode replacement]. Refer to the “High estimated loss” from [Error message list].
  - If optical fiber warps or is bent, place the optical fiber’s bent direction to face the bottom. Splice loss varies depending on cutting angle, discharge condition and cleanliness level of optical fiber. Splice loss is still high or irregular even after implementing the above recovery measures, contact to Ilsintech. Annual maintenance is required to keep splice quality.
  
- Monitor is suddenly turned off.
  - Refer to [Monitor sleep mode menu].
  
- Power is suddenly turned off.
  - Refer to [Splicer sleep mode menu].
  
- Either discharge amount or discharge time cannot be changed.
  - On SM, NZ, MM or AUTO mode, either discharge amount or discharge time cannot be changed. Implement [discharge amount calibration], and the discharge amount on these modes is properly maintained. When used on another mode, discharge amount and discharge time are automatically set to prevent their alteration.

- I'd like to set pause.
  - Refer to [Option menu].
- I'd like to indicate cutting angle, optical fiber's angle and core/clad deviation.
  - Refer to [Option menu].
- Estimated splice loss and measured splice loss does not match.
  - The estimated splice loss is a calculated value so it should be used only as a reference.

### 9.3 Sleeve heater

- Optical fiber protecting sleeve is not contracted completely.
  - Increase the heating time. Refer to [Heater mode edition].
- Heater is overheated.
  - Stop the heater by pressing , turn the power off and then contact to Ilsintech.
  - If the protecting sleeve melts and it sticks to the heater cover, remove it by pushing with cotton swab.
- I'd like to initialize heater mode's heating condition.
  - Refer to [Heater mode edition].
- I'd like to cancel heater in the middle of operation.
  - Heater operation cannot be canceled
  - by pressing . Cancel it by pressing  once again.

## 9.4 Others

- I'd like to restrict splice mode and heater mode setting.
  - Refer to [Menu lock].
  
- Splice mode's discharge amount does not change even after [Discharge amount calibration].
  - The internal standard discharge amount is calibrated. Therefore, discharge amount of each splice mode does not change.
  
- I forgot the password.
  - Contact to Ilsintech.

## X. Warranty and Repair

---

### Responsibility limit

Ilsintech guarantees its product regarding the product's material and flaws on manufacture. Upon normal use and service, we guarantee the entire hardware of the product for the term of guarantee. When a problem is incurred during the term of guarantee, the product is to be repaired or exchanged free of charge by Ilsintech's own judgment. When a flaw or damage is incurred for the reasons below, however, the repair expense may be charged to a customer even under warranty.

- i. Natural disaster
- ii. Abnormal voltage supply
- iii. User's careless handling
- iv. Product handling with disregard on working procedure or directions written on instructions for use
- v. Consumables (electrode, etc)

### 10.1 Information necessary for repair

Before sending the product, contact to Ilsintech first.

- i. Give us following information by attaching paper on the product.  
(Name, Department, Company, Address, Contact information, FAX, E-MAIL)
- ii. Product's serial number
- iii. Product's state and problem incurred, Information on error message
- iv. Product handling with disregard on working procedure or directions written on instructions for use

## 10.2 Transportation

As Swift K11 is a high-precision device, please send it put in the transporting case to protect it from humidity, vibration and shock. When requesting the product repair, send its components as well by putting them in the transporting case.

## 10.3 Repair

Newly made splice mode or splice result can be deleted depending on the repair work.

# Product Warranty

Product name		SWIFT K11	
Manufacture no.			
Date of purchase			
Customer	Name		Tel.
	Address		

## Warranty

1. This product is manufactured through strict quality management and inspection.
2. This product is subject to 1-year, free-of-charge A/S since its purchase. When charged service is required, however, the service is charged even under warranty.
3. Present the product warranty when the repair is required for the product.
4. As this product is a high-precision device, please carry it by using the product's bag at all times to protect it from humidity, vibration and shock.

## Charged service

In the following cases, service fee (repair, component and travel expenses) is charged even under warranty.

1. Breakdown or damage due to natural disasters
2. Breakdown or damage due to abnormal voltage supply
3. Breakdown or damage due to user's careless handling
4. Breakdown or damage due to product handling with disregard on working procedure or directions written on instructions for use
5. When the seal is damaged

---

❖ When maintenance required, contact to service center or seller.